

FORM PTO-1390 (Modified)
(REV 11-2000)

U.S. DEPARTMENT OF COMMERCE PATENT AND TRADEMARK OFFICE

ATTORNEY'S DOCKET NUMBER

TRANSMITTAL LETTER TO THE UNITED STATES
DESIGNATED/ELECTED OFFICE (DO/EO/US)
CONCERNING A FILING UNDER 35 U.S.C. 371

219413US0XPCT

U.S. APPLICATION NO. (IF KNOWN, SEE 37 CFR

10/069565

INTERNATIONAL APPLICATION NO.
PCT/FR00/02374

INTERNATIONAL FILING DATE
25 August 2000

PRIORITY DATE CLAIMED
27 August 1999

TITLE OF INVENTION

METHOD AND INSTALLATION FOR REMOVAL OF METAL CATIONS FROM A LIQUID BY RESINS WITH
POLYAZACYCLOALKANES GRAFTED ON A SUPPORT

APPLICANT(S) FOR DO/EO/US
CHOLLET Herve et al.

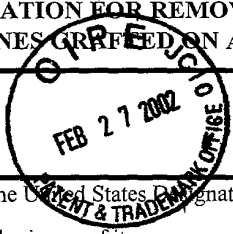

Applicant herewith submits to the United States Designated/Elected Office (DO/EO/US) the following items and other information:

- 1. This is a **FIRST** submission of items concerning a filing under 35 U.S.C. 371.
- 2. This is a **SECOND** or **SUBSEQUENT** submission of items concerning a filing under 35 U.S.C. 371.
- 3. This is an express request to begin national examination procedures (35 U.S.C. 371(f)). The submission must include items (5), (6), (9) and (24) indicated below.
- 4. The US has been elected by the expiration of 19 months from the priority date (Article 31).
- 5. A copy of the International Application as filed (35 U.S.C. 371 (c) (2))
 - a. is attached hereto (required only if not communicated by the International Bureau).
 - b. has been communicated by the International Bureau.
 - c. is not required, as the application was filed in the United States Receiving Office (RO/US).
- 6. An English language translation of the International Application as filed (35 U.S.C. 371(c)(2)).
 - a. is attached hereto.
 - b. has been previously submitted under 35 U.S.C. 154(d)(4).
- 7. Amendments to the claims of the International Application under PCT Article 19 (35 U.S.C. 371 (c)(3))
 - a. are attached hereto (required only if not communicated by the International Bureau).
 - b. have been communicated by the International Bureau.
 - c. have not been made; however, the time limit for making such amendments has NOT expired.
 - d. have not been made and will not be made.
- 8. An English language translation of the amendments to the claims under PCT Article 19 (35 U.S.C. 371(c)(3)).
- 9. An oath or declaration of the inventor(s) (35 U.S.C. 371 (c)(4)).
- 10. An English language translation of the annexes to the International Preliminary Examination Report under PCT Article 36 (35 U.S.C. 371 (c)(5)).
- 11. A copy of the International Preliminary Examination Report (PCT/IPEA/409).
- 12. A copy of the International Search Report (PCT/ISA/210).

Items 13 to 20 below concern document(s) or information included:

- 13. An Information Disclosure Statement under 37 CFR 1.97 and 1.98.
- 14. An assignment document for recording. A separate cover sheet in compliance with 37 CFR 3.28 and 3.31 is included.
- 15. A **FIRST** preliminary amendment.
- 16. A **SECOND** or **SUBSEQUENT** preliminary amendment.
- 17. A substitute specification.
- 18. A change of power of attorney and/or address letter.
- 19. A computer-readable form of the sequence listing in accordance with PCT Rule 13ter.2 and 35 U.S.C. 1.821 - 1.825.
- 20. A second copy of the published international application under 35 U.S.C. 154(d)(4).
- 21. A second copy of the English language translation of the international application under 35 U.S.C. 154(d)(4).
- 22. Certificate of Mailing by Express Mail
- 23. Other items or information:

PCT/IB/304
PCT/IB/308
Form PTO-1449 / Request for Priority
Drawings (5 sheets) / Cited References (3)

U.S. APPLICATION NO. (IF KNOWN, SEE 37 CFR **10/069565**) INTERNATIONAL APPLICATION NO. **PCT/FR00/02374** ATTORNEY'S DOCKET NUMBER **219413US0XPCT**

24. The following fees are submitted:

BASIC NATIONAL FEE (37 CFR 1.492 (a) (1) - (5)) :

<input type="checkbox"/> Neither international preliminary examination fee (37 CFR 1.482) nor international search fee (37 CFR 1.445(a)(2)) paid to USPTO and International Search Report not prepared by the EPO or JPO	\$1040.00	CALCULATIONS PTO USE ONLY	
<input checked="" type="checkbox"/> International preliminary examination fee (37 CFR 1.482) not paid to USPTO but International Search Report prepared by the EPO or JPO	\$890.00		
<input type="checkbox"/> International preliminary examination fee (37 CFR 1.482) not paid to USPTO but international search fee (37 CFR 1.445(a)(2)) paid to USPTO	\$740.00		
<input type="checkbox"/> International preliminary examination fee (37 CFR 1.482) paid to USPTO but all claims did not satisfy provisions of PCT Article 33(1)-(4)	\$710.00		
<input type="checkbox"/> International preliminary examination fee (37 CFR 1.482) paid to USPTO and all claims satisfied provisions of PCT Article 33(1)-(4)	\$100.00		
ENTER APPROPRIATE BASIC FEE AMOUNT =		\$890.00	
Surcharge of \$130.00 for furnishing the oath or declaration later than <input type="checkbox"/> 20 <input type="checkbox"/> 30 months from the earliest claimed priority date (37 CFR 1.492 (e)).		\$0.00	
CLAIMS	NUMBER FILED	NUMBER EXTRA	RATE
Total claims	37 - 20 =	17	x \$18.00
Independent claims	2 - 3 =	0	x \$84.00
Multiple Dependent Claims (check if applicable).			<input type="checkbox"/> \$0.00
TOTAL OF ABOVE CALCULATIONS =		\$1,196.00	
<input type="checkbox"/> Applicant claims small entity status. See 37 CFR 1.27. The fees indicated above are reduced by 1/2.		\$0.00	
SUBTOTAL =		\$1,196.00	
Processing fee of \$130.00 for furnishing the English translation later than <input type="checkbox"/> 20 <input type="checkbox"/> 30 months from the earliest claimed priority date (37 CFR 1.492 (f)).		\$0.00	
TOTAL NATIONAL FEE =		\$1,196.00	
Fee for recording the enclosed assignment (37 CFR 1.21(h)). The assignment must be accompanied by an appropriate cover sheet (37 CFR 3.28, 3.31) (check if applicable).		<input type="checkbox"/> \$0.00	
TOTAL FEES ENCLOSED =		\$1,196.00	
		Amount to be refunded	\$
		charged	\$

- a. A check in the amount of **\$1,196.00** to cover the above fees is enclosed.
- b. Please charge my Deposit Account No. _____ in the amount of _____ to cover the above fees. A duplicate copy of this sheet is enclosed.
- c. The Commissioner is hereby authorized to charge any additional fees which may be required, or credit any overpayment to Deposit Account No. **15-0030** A duplicate copy of this sheet is enclosed.
- d. Fees are to be charged to a credit card. **WARNING:** Information on this form may become public. **Credit card information should not be included on this form.** Provide credit card information and authorization on PTO-2038.

NOTE: Where an appropriate time limit under 37 CFR 1.494 or 1.495 has not been met, a petition to revive (37 CFR 1.137(a) or (b)) must be filed and granted to restore the application to pending status.

SEND ALL CORRESPONDENCE TO:



22850

 SIGNATURE _____
 REGISTRATION NUMBER 30,988

 NAME

 REGISTRATION NUMBER
 February 27, 2002

 DATE

219413US-0PCT

IN THE UNITED STATES PATENT & TRADEMARK OFFICE

IN RE APPLICATION OF :

HERVE CHOLLET ET AL : ATTN: APPLICATION DIVISION

SERIAL NO: NEW U.S. PCT APPLN :
(Based on PCT/FR00/02374)

FILED: HEREWITH :

FOR: METHOD AND INSTALLATION
FOR REMOVAL OF METAL
CATIONS FROM A LIQUID BY
RESINS WITH
POLYAZACYCLOALKANES
GRAFTED ON A SUPPORT

PRELIMINARY AMENDMENT

ASSISTANT COMMISSIONER FOR PATENTS
WASHINGTON, D.C. 20231

SIR:

Prior to examination on the merits, please amend the above-identified application as follows.

IN THE CLAIMS

Please amend the claims as follows:

4. (Amended) Method according to Claim 1 in which the conditioning of said resin is carried out by contacting said resin with a buffer solution, especially aqueous, in which the pH is 4 to 6, possibly preceded and/or followed by a rinsing of the resin with a major solvent of the liquid to be treated, especially with distilled water.

7. (Amended) Method according to Claim 5 in which said regeneration is carried out by passing a regeneration solution through the column(s) in the reverse direction from the direction of circulation of the liquid to be treated.

9. (Amended) Method according to Claim 7 in which at the end of the regeneration step, said regeneration solution containing the metals initially fixed on the resin is treated to recover the metals.

10. (Amended) Method according to Claim 1 comprising a prior step for treatment of the liquid by contacting with an ion exchanger or organic or mineral adsorbent different from said polyazacycloalkane resin grafted on a support.

17. (Amended) Method according to Claim 1 in which the treated liquid is an aqueous liquid.

18. (Amended) Method according to Claim 1 in which the treated liquid is a radioactive aqueous effluent with low activity.

20. (Amended) Method according to Claim 16 in which the liquid is a biological fluid, such as blood and the cations removed are copper and aluminium.

21. (Amended) Method according to Claim 1 in which said chelating ion exchange resin formed from polyazacycloalkane grafted on a solid support fulfils one of the three formulas (I), (II) and (III) below:

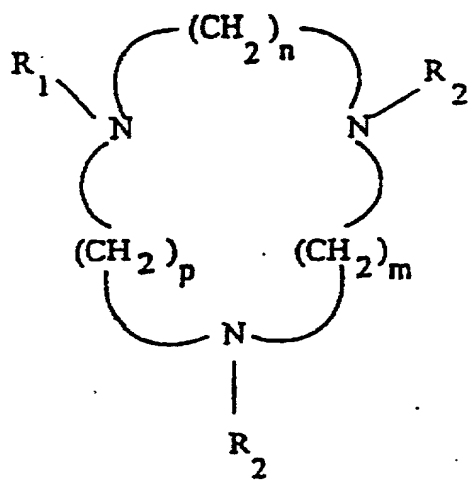

(I)

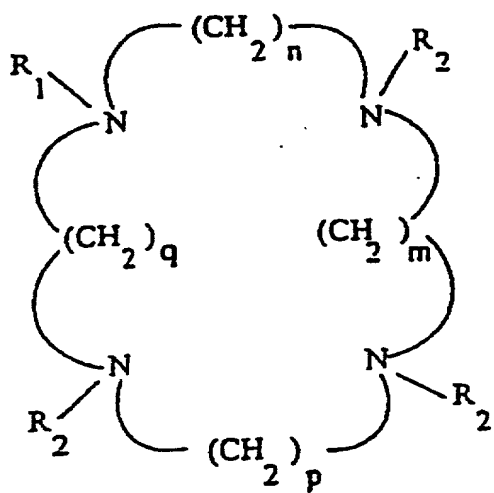

(II)

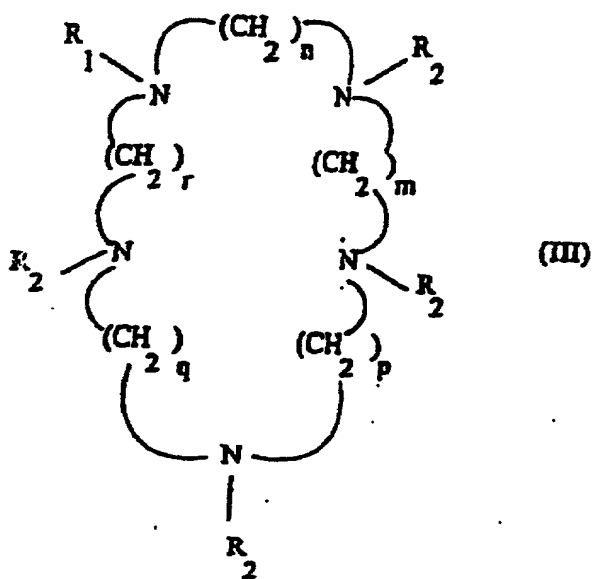

in which n, m, p, q, r which may the same or different are equal to 2 or 3, R₁ is a solid support, R₂ represents the hydrogen atom or the (CH₂)₂-R₃ group, R₃ being a functional group chosen from the group formed by COOH, CONH₂, CH₂OH, CN or COOR₄, R₄ representing an alkyl or benzyl group, or R₂ represents the -(CH₂)-R₅ group, R₅ representing COOH or PO₃R₆, R₆ representing an alkyl group or hydrogen.

22. (Amended) Method according to Claim 1 in which the solid support is an organic polymer that may or may not be crosslinked.

32. (Amended) Method according to Claim 30 in which the amount of polyazacycloalkane grafted per unit weight of solid support, such as silica is greater than 0.4 mmol.g⁻¹.

35. (Amended) Installation according to Claim 33 comprising in addition, means for regenerating said chelating ion exchange resin and possibly, said ion exchanger or organic or mineral adsorbent.

Please add the following new claims:

36. (New) Method according to Claim 6 in which said regeneration is carried out by passing a regeneration solution through the column(s) in the reverse direction from the direction of circulation of the liquid to be treated.

37. (New) Method according to Claim 17, wherein the liquid is a biological fluid, such as blood and the cations removed are copper and aluminum.

REMARKS

Claims 1-37 are active in the present application. The claims have been amended to remove multiple dependencies. Claims 36 and 37 are new claims. Support for the new claims is found in the original claims. No new matter is added by this amendment. An action on the merits and allowance of claims is solicited.

Respectfully submitted,

OBLON, SPIVAK, McCLELLAND,
MAIER & NEUSTADT, P.C.



Norman F. Oblon
Attorney of Record
Registration No. 24,618

Stefan U. Koschmieder, Ph.D.
Registration No. 50,238



22850

(703) 413-3000
Fax #: (703)413-2220
NFO/kst

I:\atty\SUKOS\219413us-pr3.wpd

18. (Amended) Method according to [any one of Claims 1 to 17] Claim 1 in which the treated liquid is a radioactive aqueous effluent with low activity.

20. (Amended) Method according to Claim 16 [and Claim 17] in which the liquid is a biological fluid, such as blood and the cations removed are copper and aluminium.

21. (Amended) Method according to [any one of Claims 1 to 20] Claim 1 in which said chelating ion exchange resin formed from polyazacycloalkane grafted on a solid support fulfils one of the three formulas (I), (II) and (III) below:

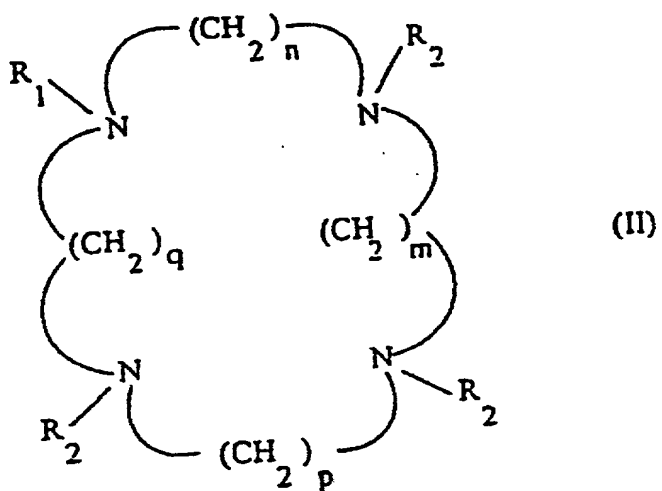
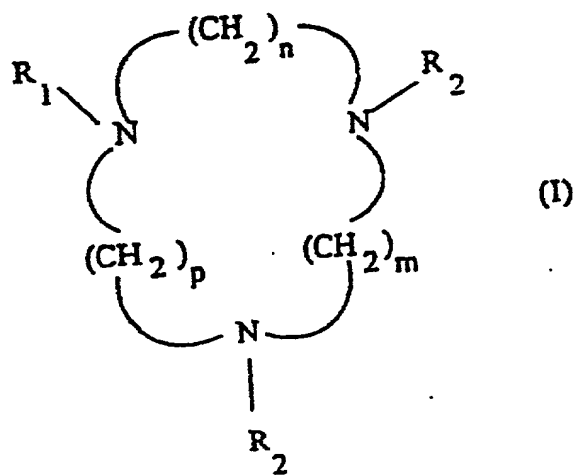

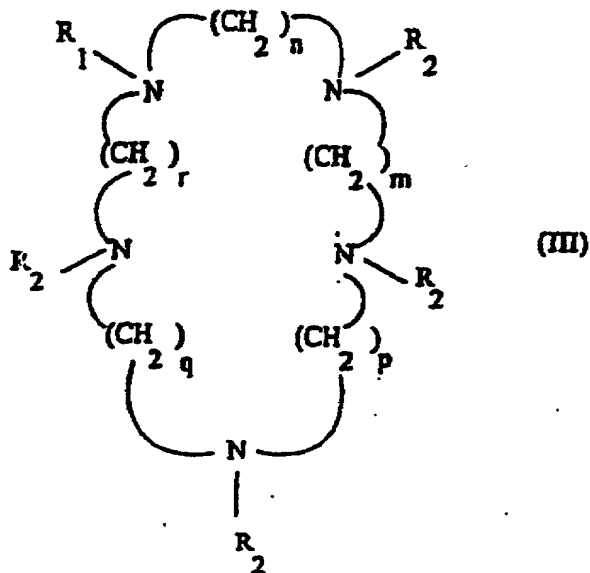

in which n, m, p, q, r which may the same or different are equal to 2 or 3, R₁ is a solid support, R₂ represents the hydrogen atom or the (CH₂)₂-R₃ group, R₃ being a functional group chosen from the group formed by COOH, CONH₂, CH₂OH, CN or COOR₄, R₄ representing an alkyl or benzyl group, or R₂ represents the -(CH₂)-R₅ group, R₅ representing COOH or PO₃R₆, R₆ representing an alkyl group or hydrogen.

22. (Amended) Method according to [any one of Claims 1 to 21] Claim 1 in which the solid support is an organic polymer that may or may not be crosslinked.

32. (Amended) Method according to Claim 30 [or Claim 31] in which the amount of polyazacycloalkane grafted per unit weight of solid support, such as silica is greater than 0.4 mmol.g⁻¹.

35. (Amended) Installation according to Claim 33 [or Claim 34] comprising in addition, means for regenerating said chelating ion exchange resin and possibly, said ion exchanger or organic or mineral adsorbent.

Claims 36-57 (New).--

5/pst

1

METHOD AND INSTALLATION FOR REMOVAL OF METAL CATIONS
FROM A LIQUID BY RESINS WITH POLYAZACYCLOALKANES GRAFTED
ON A SUPPORT

The invention concerns a method and an installation for removal of metal cations from a liquid using chelating ion exchange resins formed from a polyazacycloalkane grafted on a support.

5 Said metal cations may be heavy metals, such as copper, zinc, tantalum or gold and are more particularly cations of radioactive elements from the actinide or lanthanide family and thus the present invention is applied, more particularly, to the total decontamination
10 of alpha contaminated aqueous effluents.

In order to strictly limit the production of nuclear wastes and to preserve the environment, the effluents from factories for retreating spent fuel as well as the effluents from nuclear research centres must respect the
15 discharge standards related to liquid effluents which are more and more severe.

Thus, for example, the CEA centre (ATOMIC ENERGY COMMISSION) of VALDUC must respect the following discharge standards where they concern the liquid
20 effluents:

The activity of the effluent must be zero; the limits of detection of radiological analysis techniques being 2 Bq/m³.

Discharges in liquid form are prohibited, only the
25 evaporation of effluents may therefore be considered.

The current treatment cycle of effluents from the VALDUC centre includes several steps according to the level of radiological activity of the effluents. Effluents with high radioactivity are distinguished from effluents with low radioactivity. According to its activity each effluent will return to a different treatment place.

The effluents with high activity undergo a precipitation-flocculation reaction that is followed by a filtration. The filtration sludge is sent to storage, while part of the filtrates in which the load of salts is greater than 80 kg/m³ is "overconcentrated". The distillates obtained by carrying out this "overconcentration" will return to the treatment cycle of effluents with low radioactivity, while the "overconcentrates" are stored. The filtration sludge and "overconcentrates" are coated with concrete and discharged for final storage.

Effluents with low activity as well as filtrates for which the charge of salts is less than 80 kg/m³ and the distillates derived from effluents with high activity will undergo evaporation under reduced pressure in an industrial evaporator, that is, a plate column in which distillation is carried out under reduced pressure. As a result of this technique, stripping effluents with low α contamination is successful, that is, for example for the CEA centre (ATOMIC ENERGY COMMISSION) of VALDUC, effluents having a contamination less than 1.5×10^7 Bq/m³ in α elements and less than 50 g/L in saline load.

At the end of the evaporation, on the one hand, there is obtained a concentrate containing almost all the α activity and a saline load on the order of 300 g/L. This concentrate is mixed with effluents with high activity on the storage site, in order to be later treated and packaged, for example in concrete. On the other hand, evaporates are obtained that form 90% of the aqueous phase of the effluents treated, up to an activity of 300 to 500 Bq/m³ and which must undergo a later treatment of microfiltration to decrease the residual activity below discharge standards indicated above: namely, zero activity and prohibition of liquid discharges. If these standards are not respected, then the effluents involved are reinjected into the treatment cycle.

The last decontamination, done by microfiltration, causes wastes and does not allow all the radioactive elements to be treated in a single step, in fact, this technique only separates the solid particles and does not enable the removal of metals present in the soluble fraction of the effluent.

It would therefore be worthwhile to have at one's disposal a procedure enabling the last decontamination at the end of the evaporation step, that is, the treatment of evaporates derived from the industrial evaporation tower with a view to removing the last traces of α -emitting elements, this method not presenting the drawbacks of the treatment by microfiltration.

Moreover, it would also be worthwhile to perfect a method allowing treatment of the effluents upstream of the industrial evaporator. In fact, the evaporation treatment does not allow a zero activity to be reached directly, which definitely requires the last treatment described above, and this evaporation technique is awkward to use and relatively costly in energy. It would therefore be useful to possibly replace the evaporation tower, while obtaining effluents in which the activity conforms to the above standards.

The extraction of heavy metals, actinides and especially uranium, plutonium and americium gave rise to a large amount of research. "Crown ether" derivatives that are not soluble in water and fixed on silica have been used in extraction methods especially for extracting lead, see for example the patent US-A-4 943 375. Likewise, these crown ether derivatives have also been used in the absorption method on resin, see for example the patent application EP-A-0 433 175. This method allows recovery of part of the plutonium from concentrated solutions of fission products or of effluents from retreatment installations. However, such a method does not make it possible to attain sought values of the discharge standards.

In order to remedy this problem, the document FR-A-2 725 552 proposes a partial α -decontamination method of an aqueous effluent containing at least one polluting element chosen from copper, zinc, tantalum, gold, the actinides or the lanthanide. This method

consists of bringing said effluent into contact with a silica gel and of separating said decontaminated gaseous effluent and the silica gel that has fixed at least one of said polluting elements; the effluent to be treated
 5 having a pH greater than or equal to 3.

This method makes it possible to carry out effective decontamination of the polluting elements, but only very partial. Very few instructions related to the operating method are given, especially where it concerns possible
 10 prior conditioning of the resin.

Recourse to complexing agents and also a worthwhile route for providing a last decontamination treatment solution of effluents with low radioactivity derived from evaporation towers and/or for replacing these towers
 15 [sic].

From the prior art macrocyclic compounds are already known that have excellent complexing properties with respect to cations, anions or even neutral molecules. Thus, the document FR-2 643 370 describes derivatives
 20 with the following general formula:

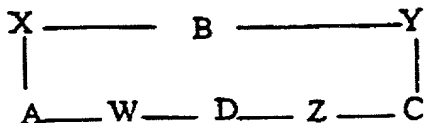

in which A, B, C and D may represent $-(CH_2)_x-$, x being
 25 between 1 and W, X, Y and Z may represent $=N-(CH_2)_y-COR$,

y being between 1 and 4 and R representing OH, NH₂ or OR' group. These derivatives may be used as complexing agents for metal elements and in complexed form as oxygen traps.

However, these macrocyclic derivatives are generally
5 very soluble in water. Because of this, the use, the recovery and the regeneration of these derivatives in solution are not very easy. For these reasons, several modes of fixation have been developed for grafting these
10 macrocyclic derivatives on organic or inorganic supports that are not soluble in water. Thus, the patent US-4 943 375 reveals a macrocycle grafted on silica, usable in a separation column for trapping a given ion present in a solution of several ions.

The patent application FR-2 613 718 describes cyclic
15 tetramines grafted on a polymer and likely to be used for selective extraction and/or measuring ions of transition metals and heavy metals. However, these grafted macrocycles present the drawback of not being selective for a particular type of metals.

20 In the nuclear field, the patent application EP-0 347 315 describes a method for separating, by means of crown ethers, uranium and plutonium present in an aqueous medium originating from the retreatment of spent nuclear fuels. The crown ether may be DCH 18C6, DCH 24C8
25 or DB 18C6.

Finally, the document WO-A-96 11056 concerns substituted polyazacycloalkanes grafted on a support such as silica and their use for the removal of metal cations from a liquid, in particular cations of transition

metals, heavy metals, metals from Group IIIa, lanthanides or actinides.

However, the decontamination obtained by the method of this document using such complexing agents is still
5 insufficient and did not satisfy the standards mentioned above, and in particular, does not allow the elimination of the last microfiltration.

It is evident from the preceding that there is an unsatisfied need for a method and an installation
10 bringing complexing agents into play that are less expensive and effective, that especially allow the treatment of evaporates from industrial evaporation towers, in order to totally remove the last traces of α -emitting elements and/or that ensures the treatment of
15 effluents upstream of the industrial evaporation tower, in order to be able to replace this tower while obtaining effluents presenting activities in conformance with the discharge standards given above.

A need still exists for a method that entirely
20 fulfils these requirements, in terms of decontamination, in a limited number of steps, without involving a final treatment, for example by microfiltration.

The goal of the present invention is to provide a method and an installation for removal of metal cations
25 from a fluid, more precisely, a decontamination method that satisfies the needs given above.

The goal of the present invention is, in addition, to provide a method and a device for removal of metal cations from a fluid that does not present the drawbacks,

limitations, defects and disadvantages of methods and devices of the prior art and which solves the problems of the prior art.

5 This goal and others are reached still in conformance with the present invention by a method of removal of metal cations contained in a liquid, in which said liquid is brought into contact at a temperature higher than or equal to 60°C with a chelating ion exchange resin formed from polyazacycloalkane grafted on a solid support, said resin having been conditioned, previously
10 to said contacting, at a pH of 4 to 6.

According to the invention, it has been noted surprisingly, that the fact of performing the contacting in the specific range of temperatures given above, and in
15 addition, of carrying out said contacting after having previously conditioned said resin at a specific pH, made it possible to obtain considerably improved fixation capacities and selectivity with respect to actinides.

Among the numerous parameters controlling the
20 process of fixation of cations and influencing the capacity of the resins, it did not clearly follow that it was definitely the contacting temperature, as well as the conditioning pH that has a decisive influence on their capacity.

25 This note goes counter to what is currently accepted in this field of the technique where it is known that such conditioning has only little or no effect on the conventional silica gels or resins of the AMBERLITE® type.

In addition, it was even less predictable that the fact of being placed in specific ranges of these two specific parameters would lead to a surprising improvement of the capacity of the resins. This capacity
5 being, in addition, combined with a very great selectivity especially with respect to the actinides.

In other words, the invention originates from a selection of two parameters among infinity of parameters, then with the selection of narrow ranges of values of
10 these two parameters and finally with the combination of these specific ranges of these specific parameters.

It is to be noted that this conditioning pH must not be confused with the pH at which the contacting is carried out, in fact, the method according to the
15 invention enables liquids to be treated in a wide range of pH values, as much acid or very acid as basic or very basic, independent of the range of specific pH values at which the conditioning takes place. In other words, even
20 if the conditioning is carried out in the above range of pH values, such conditioning does not limit the treatment to liquids with specific pH values, for example, one could by the method of the invention treat all types of effluents having a pH from 5 to 9 such as effluents at pH
7 from the evaporation tower.

25 Preferably, according to the invention, the contacting is carried out at a temperature going from 60°C to a temperature lower than the boiling temperature of the liquid at the pressure prevailing during contacting, preferably still the contacting is carried out at a

temperature of 60 to 80°C and the pH of the conditioning of the resin is 4 to 5, for these ranges the best capacity and selectivity is obtained.

5 The conditioning (or reconditioning) of the resin is generally carried out by contacting said resin with a buffer solution, for example, an aqueous buffer solution in which the pH is located in the range mentioned above, for example 4.7. By way of example of buffer solution, a buffer of the acetic acid-sodium acetate type may be
10 mentioned; this contacting with the buffer solution may be possibly preceded and/or followed by a rinsing of the resin with the main solvent of the liquid to be treated, for example with distilled water.

15 Advantageously, according to the invention, the method is carried out continuously, said resin being placed in at least one column through which passes a current of the liquid to be treated.

The method according to the invention may use 1 to several, for example 5 or 10 resin columns.

20 The use of resins in columns makes the method according to the invention easy to use, effective and not very expensive.

25 The conditioning of the resin is then done simply by making a buffer solution pass through the column in the direction of circulation of the liquid to be treated (in general, from the bottom to the top).

In addition and preferably, the method according to the invention comprises a regeneration step of said resin

when the latter is saturated with the fixed metals in order to recover the latter.

Preferably, said regeneration is carried out by making liquid to be treated by a regeneration solution pass through the column(s) in the reverse direction (in general from top to bottom) of the circulation direction (in general from bottom to top).

Preferably, this regeneration solution is chosen from the acid solutions with pH values from 1 to 3, for example a pH in the region of 2, for example, solutions of nitric acid, with for example a concentration of 1 to 3 mol/L.

Said regeneration solution containing the metals initially fixed on the resin may be then treated, at the end of the regeneration step to recover the metals which may have a high added value.

This treatment of the regeneration solution may for example be that described previously for said effluents with high activity.

The regeneration capacity of resins mentioned above had most certainly already been demonstrated in static mode, it is however surprising that a high regeneration capacity could also be obtained in dynamic mode. This regeneration capacity makes it possible to use the resins in an industrial decontamination method in which it is necessary to be able to recover the metals fixed on the resin in order to reuse the materials several times in succession.

Because the resins used in the method according to the invention are easily regenerated, the reconditioning of a significant amount of wastes is however avoided.

According to the invention and preferably, the method of removal comprises a step prior to treatment of the liquid by contacting with a known ion exchanger chosen from the chelating resins on the market such as resins of the polyacrylate type, such as resins known under the name of AMBERLITE®, for example, or a known organic or mineral adsorbent for example, silica, preferably, this adsorbent is chosen from silica gels, such as KIESELGEL® (MERCK®).

Such a treatment is approximately similar to the treatment described in the document FR-A-2 725 552 and the absorbents used are generally similar to those described in this document.

Such a treatment makes it possible to increase the effectiveness of the separation with respect to certain metals such as the alkaline-earth metals and the transition metals. It makes possible a partial purification of the liquid and a prefiltration of the liquid and a less rapid saturation of the polyazacycloalkane resin fixed on a support. Preferably this prior treatment is also carried out continuously said ion exchanger or said adsorbent being placed in at least one column through which passes a current of liquid to be treated and positioned upstream of said column filled with resin.

In the same way as the resin, in addition, this ion exchanger or this adsorbent may be also regenerated when it is saturated by the fixed metals. Preferably, this regeneration takes place under the same conditions as the
5 regeneration of the resin and at the same time as the latter and with the same regeneration solution.

Said metal cations to be removed that are contained in the fluid are preferably metal cations chosen from transition metals, heavy metals, metals from group IIIA
10 of the periodic table, lanthanides, actinides, alkaline-earth metals. Just in the configuration with (at least) two columns, the heavy metals and the lanthanides and actinides are fixed selectively by the second column and the alkalis and alkaline earths by the first column which
15 preserves the second resin column.

In particular these cations are chosen among the cations of U, Pu, Am, Ce, Eu, Al, Gd, Cr, Mn, Fe, Co, Ni, Cu, Zn, Ag, Cd, B, Au, Hg, Pb, As, Ca, Sr, Mg, Be, Ba and Ra.

20 The liquid treated by the method of the invention may be any one but it preferably concerns an aqueous liquid. This liquid may be an industrial effluent, urban or another, it is preferably a radioactive effluent, for example an α -contaminated effluent, preferably with low
25 activity, in which said cations are cations of radioelements.

This effluent, preferably aqueous, may be derived from a factory for retreatment of nuclear wastes, from a nuclear laboratory or any other installation, in which

radioactive substances are used, preferably this effluent is the aqueous effluent with low activity derived from industrial evaporator of the treatment installation of effluents from a nuclear installation.

5 The method according to the invention may for the treatment of effluents with low activity, replace the existing step resorting to an industrial evaporator and to a last treatment by microfiltration because the method according to the invention makes it possible to purify
10 directly all the effluents with low activity without another later treatment and to reach zero activity. Or else the method according to the invention may take place downstream of the evaporation step bringing into play an industrial evaporator for carrying out a last
15 decontamination in a single step, and replacing the microfiltration step by ensuring the removal of metals present in the soluble fraction of the effluents.

Said liquid may also be a biological fluid, such as blood, in which case the cations removed will be copper
20 or aluminium, for example.

It is to be noted that the nature of the resin used may be adapted according to the cation(s) that are desired to be retained and according to the effluent.

The chelating ion exchange resin used in the method
25 of the invention and formed from polyazacycloalkane grafted on a support are described for the most part in the document WO-A-96 11056 and fulfil one of the three formulas (I), (II) and (III) below:

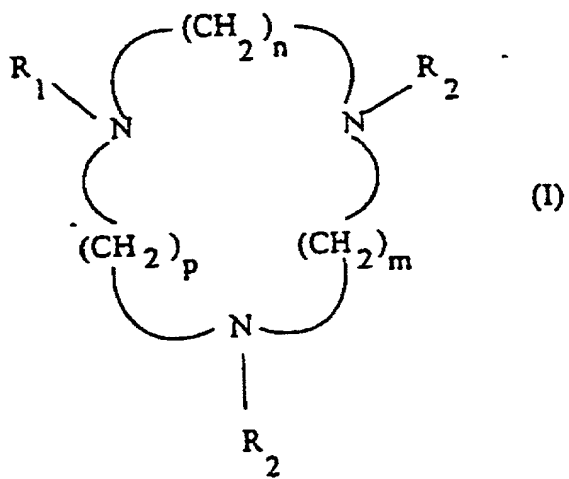

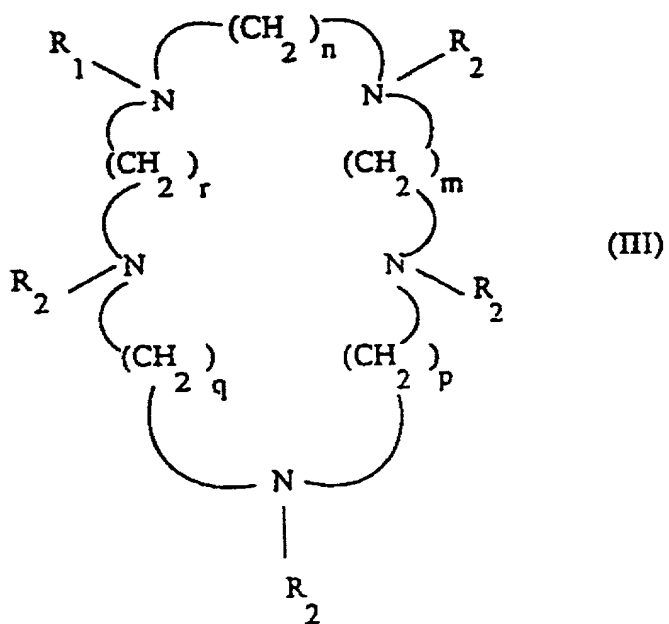
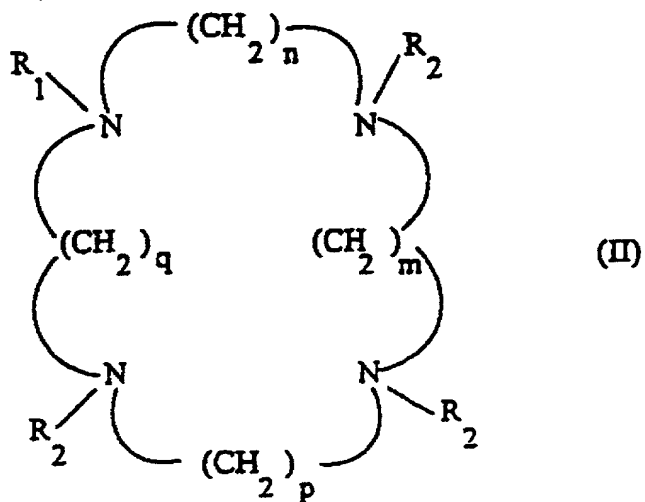

in which n , m , p , q , r which may be the same or different are equal to 2 or 3, R_1 is a solid support, R_2 represents the hydrogen atom or the $(CH_2)_2-R_3$ group, R_3 being a

5

functional group chosen from the group formed by COOH, CONH₂, CH₂OH, CN or COOR₄, R₄ representing an alkyl or benzyl group, or R₂ represents the -(CH₂)-R₅ group, R₅ representing COOH or PO₃R₆, R₆ representing an alkyl group or hydrogen.

The silica gels S, such as used in the invention (and which may also be used in the prior treatment) are defined for example in KIRK-OTHMER, Encyclopaedia of Chemical Technology; 3rd edition, Vol. 20, p. 773-775.

The solid support may be an organic polymer that may or may not be crosslinked and in particular a residue of an organic polymer that may or may not be crosslinked, with alkyl halide or alkyl chloride end, such as a residue of chloromethyl polystyrene with the formula:

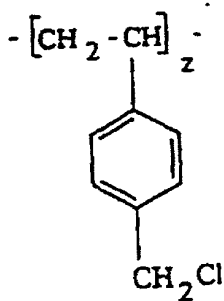

or may be a derivative of silica fulfilling formula:

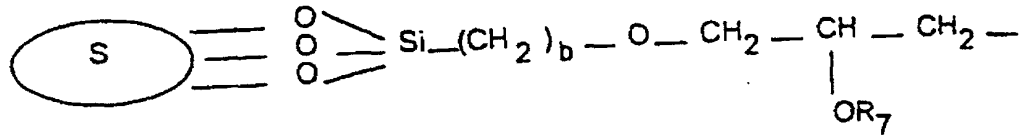

or the formula:

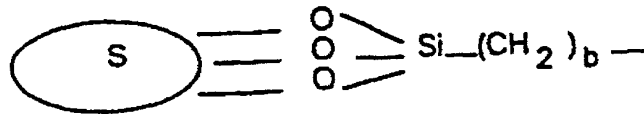

5

S representing a silica gel, b being between 1 and 4 and preferably equal to 3 and R7 being an alkyl group or a hydrogen atom.

10 Residue of an organic polymer that may or may not be crosslinked with alkyl halide end is understood to be a polymer in which the halogen(s) is (are) entirely or partially substituted.

15 Preferably, the grain size distribution of the chloromethyl polystyrene and that of the solid support derived from silica are between 20 and 400 mesh or better between 20 and 70 mesh. It is the grain size distribution of the chloromethyl polystyrene and not the grain size distribution of the rest that may be different.

Preferably, according to the invention all the nitrogen atoms of the macrocycles are substituted by identical ester groups: acetates, propionate etc.

When all the nitrogen atoms of these different
5 macrocycles are substituted by the same ester groups,
such as acetate, propionate, the macrocycles present
remarkable properties of complexing with metals of the
lanthanide and actinide series and especially europium
and gadolinium. X-ray analysis shows that the
10 coordination of the metal atom with the macrocycle is
carried out by oxygen atoms of the carboxylate groups
when the nearby macrocycles described for example in the
article by SPIRLET et al., Inorg. Chem., 1984, 359-363 or
in the article by DUBOST et al., C.R. Acad. Sci., Paris
15 Ser. 2, 1991, 312, 349-354, the metal atom is coordinated
with nitrogen and oxygen atoms at the same time [sic].
This result is attributable to the nature of the groups
carried on the nitrogen atoms of the macrocycles.
Preferably, the macrocycles or all the substituents of
20 nitrogen are ester groups such as propionate, acetate,
are grafted on a silica gel.

Likewise, the nature of the support may be adapted
according to the effluent treated: thus, when the solid
support is silica gel, the product obtained is with
25 reduced expense, surprisingly, easily regenerable by
simple treatment of the acid, even in dynamic mode,
stable in most organic solvents and inert with respect to
numerous chemical products.

In addition, this product may be used under pressure, in combustive or oxidizing medium.

When the solid support is of the MERRIFIELD resin type (trademark filed) marketed by the ALDRICH Company the product obtained is physiologically inert and may be used as selective complexing agent for blood elements, for example for elimination of the cation Cu^{2+} in a dialysis treatment.

In the remainder of the description, the names of the polyazacycloalkanes according to the invention are presented in abbreviated form for the purposes of simplification. More precisely, the polyazacycloalkanes with four nitrogen atoms are referenced with the form "R1, a series of figure, R2" and fulfilling the general formula:

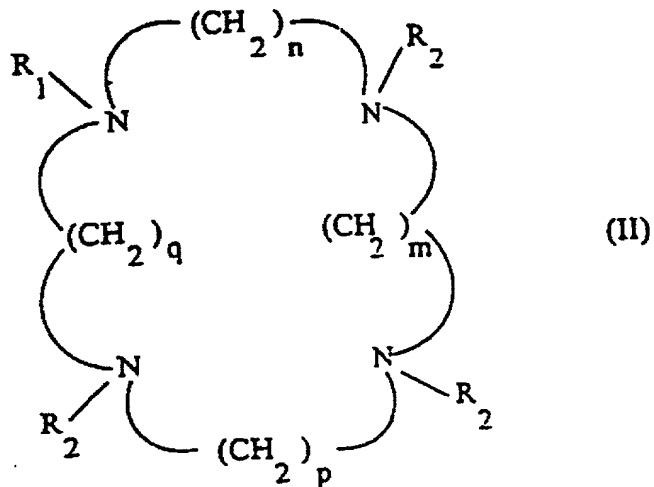

R1 representing the Si support, hydroxy or Me Si with
 "Si" signifying:

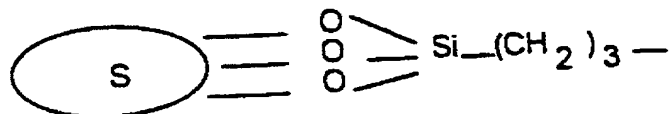

5

S = silica gel

"hydroxy Si" signifying:

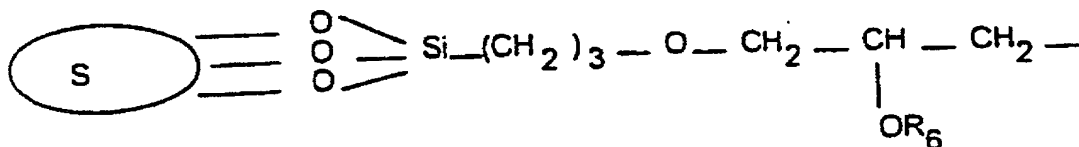

10

S = silica gel

and "Me" signifying Merrifield resin with formula:

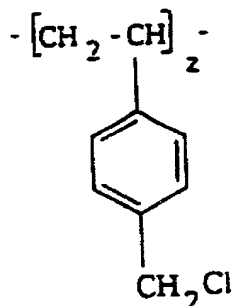

R2 representing TrP, TrA or TrMP
 with "TrP" signifying: (CH₂)₂-COOH

5 "TrA" signifying: CH₂-COOH
 and "TrMP" signifying: CH₂-PO₃H

When no indication is specified for R2, that
 signifies that R2 = H.

10 When the series of figures is 2222 or 3333 that
 signifies that n, m, p and q are all equal to 2 or 3,
 respectively. When the series of figure[s] is 2323, that
 signifies that n and p are equal to 2 and m and q are
 equal to 3 or conversely, that n and p are equal to 3 and
 m and q are equal to 2.

15 The polyazacycloalkanes with 3 or 5 nitrogen atoms
 are referenced similarly. Thus, the series of figures 232
 signifies that among n, m and p, two of these letters
 represent 2 and the other represents 3.

20 Thus, the preferred resins used in the method of the
 invention are the following resins:

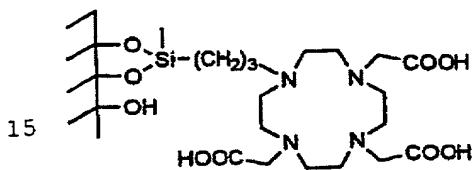

Si2222trA

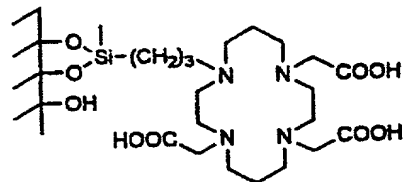

Si2323trA

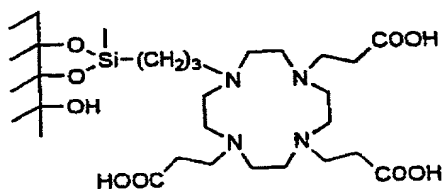

Si2222trPr

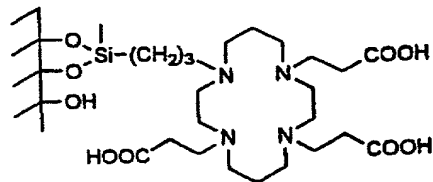

Si2323trPr

Si2323trPr is the preferred resin.

The resins used in the method according to the invention may be prepared by any appropriate method.

Thus, the resins used in the method according to the invention may be prepared by the method described in the document WO-A-96 11056 to which reference is made here fully and explicitly and for which the content is fully included in the present description.

The method described in this document consists of reacting the silica with a spacer arm, then for example with a polyazacycloalkane, such as a tetraazamacrocyclic and to next carry out substitution of the free amine

functions of the macrocycle (polyazacycloalkane) by groups especially including a carboxylic acid function.

The amount of macrocycle grafted, according to the synthesis scheme, is generally approximately 0.35 to 5 0.40 mmol.g of material. This first method that we will call for the remainder "pathway 1" has shown during its use that the synthesis steps could be incomplete.

In other words, this synthesis pathway 1 presents two major drawbacks: only 30 to 50% of the grafted spacer 10 arms in the first step react with the macrocycle. The amount of macrocycles grafted is thus found to be considerably reduced and the residual presence of functions that have not reacted may prove to be detrimental during the use of a method, such as that of 15 the present invention, using the materials for a given application.

The N-functionalization of the macrocycle for example, of the grafted tetraazamacrocycle, last step of the synthesis, is not quantitative because only one to 20 two secondary amine functions out of an available three react with the reagent.

In addition, it is not excluded that certain macrocycles may be connected by two atoms of nitrogen to the silica gel. This heterogeneity greatly harms the 25 effectiveness and the selectivity of the modified silica gel.

That is the reason for which another method of grafting is proposed for the preparation of resins used in the method of the invention.

This method, called "pathway 2" method, differs essentially from the "pathway 1" method because the order of each of the grafting steps is changed, by first reacting a macrocycle, unsubstituted polyazacycloalkane
5 such as cyclam or cyclene (and not the silica, as in the "pathway 1" method) with a spacer arm, then by grafting said compound carrying a spacer arm on the silica.

Possibly and preferably, said compound (polyazacycloalkane) carrying a spacer arm (compound A)
10 is first functionalized prior to its grafting on the silica, that is, a macrocycle (polyazacycloalkane) is synthesized, tetrasubstituted for example, prior to grafting of the latter on the silica.

An example of the "pathway 2" method without prior
15 functionalization of the compound carrying the spacer arm is given below, the starting compound being cyclam and the spacer arm fulfilling the formula:

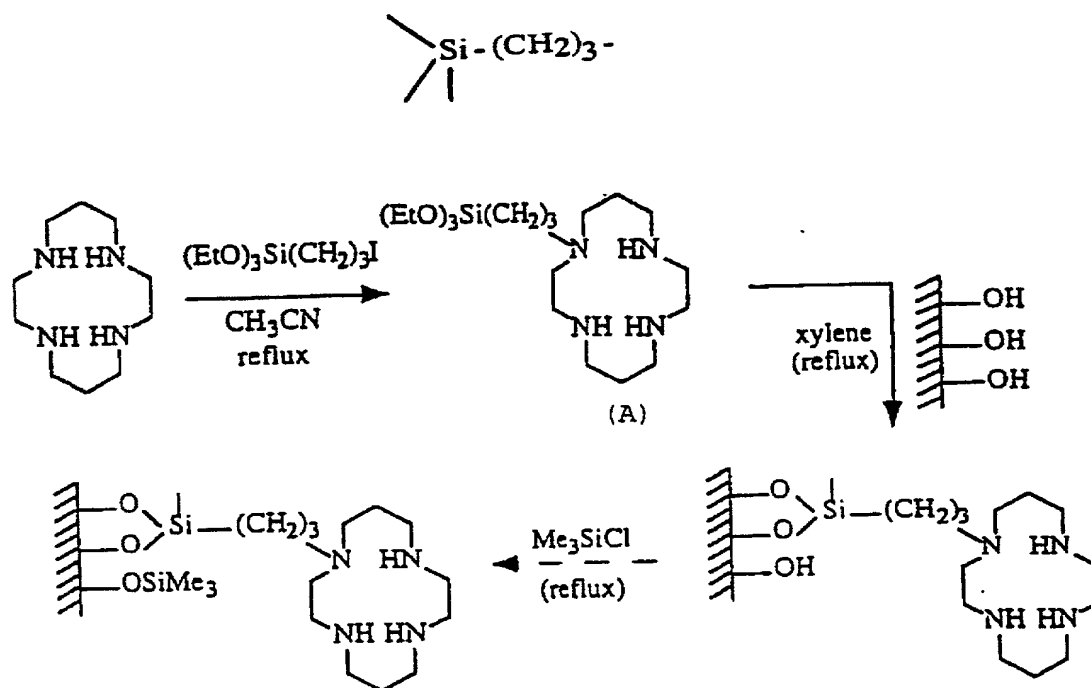

In the reaction scheme, the last step (stippled arrow) is optional; it enables free silanol groups remaining on the silica to be protected.

Iosdopropyltriethoxysilane is synthesized simply by the action of NaI on commercial chloropropyltriethoxysilane. Iodopropyltriethoxysilane in solution in acetonitrile is then added drop by drop to a solution of cyclam in acetonitrile at reflux in the presence of Na_2CO_3 . The reaction mixture is kept at reflux for 24 h, the solvent is then evaporated and pentane is added to the residue. Excess insoluble cyclam is filtered, the filtrate is concentrated and the compound (A) is obtained without later purification with a yield of 50%. The

grafting of (A) on the silica gel is carried out at reflux of xylene for 4 days. The amount of grafted macrocycles is then 0.8 mmol.g of modified silica gel, for example.

- 5 Compound (A) may possibly be functionalized, then grafted according to the scheme:

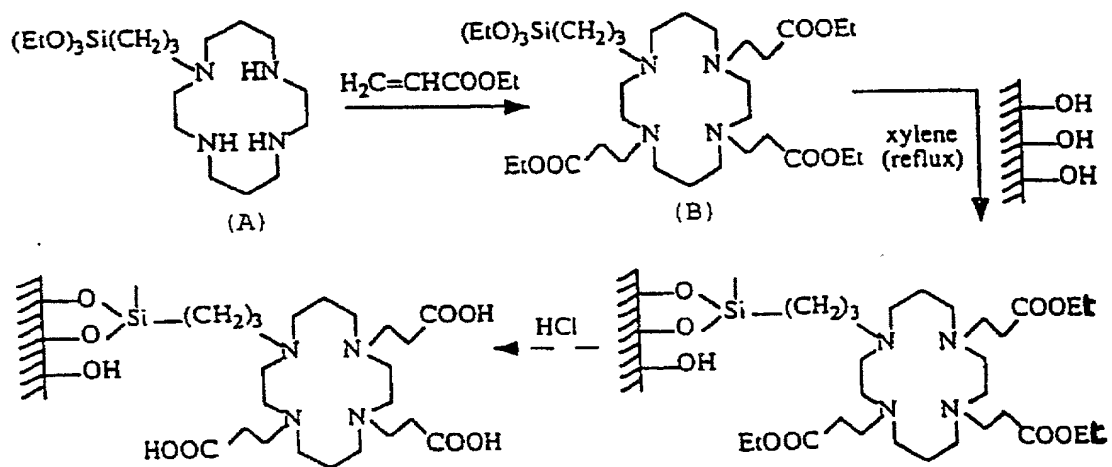

- 10 Compound A is agitated for 4 days at ambient temperature in ethyl acrylate. After evaporation of the ethyl acrylate and several washes with pentane, product B is obtained quantitatively. Grafting of B on the silica gel is then carried out as described above. The final
15 compound is the resin "Si2323trPr" according to nomenclature used in the present application.

- The last reaction step with HCl is however optional, the preceding compound with three ester functions also being likely to be used in the method according to the
20 invention.

It is very obvious that the method described above may be applied to any known unsubstituted starting macrocycle with any spacer arm, on any support including active sites, silanols or another an that the
5 functionalization reaction may be any reaction known to the person skilled in the field.

Thus, different spacer arms (containing aromatic units, ester or amide functions) may be used, likewise, the electrophilic reagent used during the N-
10 functionalization may also vary, enabling access to a large range of silica gels presenting optimal effectiveness and selectivity.

If this method is compared to that proceeding by grafting the spacer group on the silica gel, then by
15 fixation of the desired ligand on this arm, this new method generally makes it possible to double the amount of tetraazamacrocycles grafted on the surface of the silica gel. Thus, there is a significant increase in the number of "active sites" per unit of surface area and
20 considerable improvement in the effectiveness of the material following from it. The second advantage, even more important, is to be able to totally control the nature of the fixed ligand, since it is synthesized, isolated and characterized before grafting.

25 This new method of synthesis of ligands carrying spacer arms does not require any particular experimental conditions and leads to the expected compounds in suitable yields without later purification. In addition, this synthesis is carried out in a single step and not

two as in the method where hydrosilylation of the terminal alkene takes place. Finally, the N-substitution of these ligands is quantitative and enables grafting of totally N-substituted macrocycles.

5 In other words, the "pathway 2" method has the advantage of being able to prepare and characterize the tetrasubstituted macrocycle by conventional techniques of organic chemistry. This grafting method makes it possible, on the one hand, to be certain that the grafted
10 macrocycle is a good carrier, for example of three "carboxylic acid" arms, (these functions have a prime role in the complexing of actinides) and on the other hand, at least of doubling the amount of macrocycle grafted per unit of weight (see Table I).

15 Thus, the different amounts of macrocycles grafted for various resins have been determined by, elemental analysis. The results are brought together in Table I, which makes it clearly evident that the resins prepared by the method of "pathway 2" have an amount of grafted
20 macrocycle clearly greater than that of the resins prepared by the "pathway 1" method.

Table I
Amounts of macrocycles grafted for the different modified
25 silica gels

Resin	Amount of macrocycles grafted (mmol.g-1)
Si2222trA	0.24
Si2323trA	0.26

Si2222trPr	0.28
Si2323trPr ("pathway 1")	0.32
Si2323trPr ("pathway 2")	0.61

Generally, if the amount of polyazacycloalkane grafted per unit of weight of support, as a result of the methods of "pathways 1 and 2" is generally from 0.1 to several mmol.g⁻¹, preferably this amount must be as high as possible.

The amount of polyazacycloalkane grafted per unit of weight obtained by the "pathway 2" method is in addition as given above, clearly greater than that of "pathway 1", it is therefore greater than 0.4 mmol.g⁻¹, preferably greater than or equal to 0.6 mmol.g⁻¹, still preferably greater than or equal to 0.8 mmol.g⁻¹.

The "pathway 2" method is described in the French patent FR-A-2 774 092 (Application No. 98 00784) to which reference is made here fully and explicitly and for which the contents are fully included in the present description.

The invention has also dealt with the installation of use of the method according to the invention.

Such an installation for the removal of metal cations contained in a liquid essentially comprises at least one container such as a column filled or furnished with a chelating ion exchange resin formed from a polyazacycloalkane fixed on a support, means for causing a current of liquid to be treated to pass through said column, means for conditioning said resin at a pH of 4 to

6 and means for heating said resin to a temperature greater than or equal to 60°C.

In addition, the installation may include means for regenerating said resin.

5 Advantageously, in addition, the installation according to the invention comprises a container, such as a column filled with ion exchanger or organic or mineral adsorbent different from said polyazacycloalkane resin grafted on a support, placed upstream (relative to the
10 direction of circulation of the current of liquid to be treated) of said column filled with resin.

The installation according to the invention will also comprise, in addition, preferably, means for regeneration of said ion exchanger or adsorbent.

15 Other characteristics and advantages of the invention will appear better with reading the description and following examples, give by way of illustration and not limiting.

This description is made in reference to the
20 attached drawings in which:

- figure 1 is a diagrammatic view in vertical section of an installation for use of the method according to the invention, more particularly suiting treatment of effluents downstream of the industrial
25 evaporator, comprising two columns filled, respectively, with silica and polyazacycloalkane resin fixed on silica;

- figure 2 is a diagrammatic view in vertical section of an installation for use of the method according to the invention at the laboratory stage, more

particularly suiting treatment of effluents upstream of the industrial evaporator;

- figure 3 is a graph that shows the effect of temperature on the extraction of uranium (VI) at a pH of 5 and for a period of 18 h.

On the abscissa is shown the temperature $T(^{\circ}\text{C})$ and on the ordinate is shown the static partition coefficient K_{ds} (mL/g), the curve with stippled lines is related to control silica gel and the curve with unbroken line is related to the Si2323trPr resin ("pathway 1");

- figure 4 is a diagrammatic view in vertical section of the device used for the tests in dynamic mode;

- figure 5 is a graph that gives the "type" profile of elution of uranium through a column filled with modified silica gel. On the ordinate, is shown the concentration C of uranium at the outlet of the column and on the abscissa is shown the volume of eluted solution V ;

- figure 6 is a graph that gives the dynamic partition coefficient K_{dd} (1) for the Si2323trPr resin ("pathway 1") (I) and for the control silica gel according to the pH ($T = 25^{\circ}\text{C}$, uncertainty $\pm 10\%$);

- figure 7 is a graph that gives the dynamic partition coefficient (K_{dd}) (1) for the resins, Si2323trPr ("pathway 1") (I) and Si2323trPr ("pathway 2") (II) at pH 4, and for the control silica gel at pH = 9 according to the temperature $T (^{\circ}\text{C})$ (uncertainty $\pm 10\%$);

- figure 8 is a graph that represents the elution profile of uranium (VI) from a column filled with

Si2323trPr ("pathway 2") with the aid of 2N nitric acid and at ambient temperature.

On the ordinate is shown the concentration of uranium C, in g/L, and on the abscissa is shown the volume of eluted HNO3 (V) in mL;

- figure 9 is a graph that illustrates the amounts of uranium fixed (striped strips) and salted out (white strips) in mmol.g for 5 experiments carried out with the material Si2323trPr ("pathway 2") (uncertainties $\pm 10\%$).

Figure 1 is a production example of an installation for use of the method according to the invention suiting more particularly treatment of effluents downstream of the industrial evaporator comprising two columns, the first filled with silica and the second filled with resin, polyazacycloalkane fixed on silica.

This example of installation according to the invention diagrammatically includes the following parts.

- A tank (1) for receiving contaminated effluents with a volume for example of 1.5 m3 provided with sensors of tip and bottom levels, an immersion heater (2), a temperature probe (3) and an agitating system (not represented). Before receipt, the effluent is sent by a pump (5) through a filtering bowl (6) provided with cartridges for example with three cartridges with a pore diameter of 5 μm .

- A decontamination circuit composed of a metering pump (7), a first manometer (8), a first column filled with silica (9) which is provided with electric band heaters with a system for control of the temperature,

with a second manometer (10), with a reheater (11), with a second column filled, for example, with Si2323trPr resin (12), with a temperature probe (13) and a flow meter (14). Each column contains on the order of 12 L of resin. The entire pipe line is preferably stainless steel.

- A tank for receiving treated effluents (15) provided with sensors of top and bottom levels.

- An elution circuit composed of a peristaltic pump (16), a stainless steel pipe line (17, 18) and two canisters (19, 20).

In addition, the installation comprises on the piping connecting the tank (1) to the column (9) a filter (22), a solenoid valve (23) and metering pump (24). Moreover, manual valves (25) are provided between the inlets and the outlets of both columns (9) and (12). A temperature sensor (26) is placed on the piping feeding the tank for receiving treated effluents (15) and a pump (27) for sampling the effluents found in this tank for a discharge (28) after radiological analysis.

The entire installation is placed in a retention container provided with flood sensors. The heating systems, the different probes and the pumps are servo-driven with an electric panel.

The operation of the installation of Figure 1 may be described in the following way:

Previously, the effluent to be treated, dispatched for example by water tank car, is carried along by the pump (5) through the filter with cartridges (6) in order

to remove the impurities and solid particles (sludge, algae etc.). In fact, the extraction methods on the solid phase generally are very sensitive to fouling and must be protected upstream by a filtration system. The effluent
5 "proper" is then admitted to the tank for receiving contaminated effluents (1).

The operation of the installation may be broken down into two phases:

1) Fixation: The effluents are carried along by
10 the metering pump (7) successively through the two columns (from bottom to top) (9) and (12), filled, respectively, with silica and resins, for example Si2323trPr resin.

According to the invention, the temperature of the
15 effluent during passage on the column of resin is preferably 60°C. The heating of the effluent is carried out simultaneously with the aid of the immersion heater (2), electric band heaters and reheater (11). The flow rate of the effluent during this fixation phase is
20 between 30 and 60 L/h, for example. The effluent is next recovered in the tank for receiving treated effluents (15).

If the radiological analysis (29) does not indicate any trace of contamination, the effluent is then, for
25 example, directly transferred to the industrial evaporator for carrying out the final evaporation or discharged to the environment (28).

In case of contamination, the effluent is then reinjected into the beginning of the method in the tank for receiving contaminated effluents (1).

2) Regeneration: A solution of nitric acid, 1N for example (19) is carried along by the peristaltic pump (16), independently through the desired column, countercurrent (from top to bottom). Of course, because of the high capacity of resins and the very low activity of the effluents to be treated, this is not a very frequent operation.

At the end of regeneration, the resins require reconditioning before beginning a new cycle. The reconditioning is carried out by injection of water, a buffer solution at pH 4.7, then a last rinsing with water by using the same circuit.

In the examples that follow, the role of the temperature and the conditioning pH as well as the nature of the ligand is shown on the capacities of the resins of polyazacycloalkanes grafted on silica.

First, a study is carried out in the static mode, then in the dynamic mode.

Example 1

In this example, the capacity of the resins used in the method of the invention to trap uranium is studied in the static mode. This capacity is determined by "batch" experiments with contacting of the sequestering agent in the presence of excess salt under predetermined conditions, especially of pH and temperature.

The operating method of the tests in the static mode is the following.

A known weight (approximately 100 mg) of resin dried under vacuum is placed in a flask containing 10 mL of a solution of 1g.L-1 of uranyl nitrate at pH 5. The entirety is agitated at a constant temperature for 18 h. Next, the resin is filtered and rinsed with distilled water. The filtrate and the rinsing water are collected and adjusted to 50 mL in a volumetric flask. The concentration of U (VI) is determined by ICP-AES. The amount of fixed U (VI) is calculated relative to the concentration of U (VI) before and after extraction.

Two experiments are carried out for each modified silica.

The total capacity is calculated by considering the amount of uranium extracted, relative to the weight of resin and to the volume of solution through the static partition coefficient Kds.

For each experiment carried out, the static partition coefficient Kds is calculated according to the following formula:

$$Kds = \frac{[\text{amount of uranium trapped}]/[\text{weight of dry resin}]}{[\text{amount of uranium remaining in solution}]/[\text{volume of the solution}]}$$

$$Kds = \frac{[Co] - [C]}{[C] \times V/m}$$

[Co] = concentration of the solution before extraction (g.mL⁻¹)

[C] = concentration of the solution after extraction (g.mL⁻¹)

5 V = volume of the solution (mL)

m = weight of the resin (g)

The partition coefficient K_{ds} directly reflects the capacity of the material to fix the metal. This partition coefficient may a priori be infinity, but it is often equal to several hundreds, even sometimes, several thousands.

Example 1A

15 In this example the effect of the temperature on the extraction of uranium VI is studied. The operating method is that described above, but furthermore, the solution is heated during extraction.

20 Thus, the static partition coefficients obtained for a silica gel of the KIESELGEL® (MERCK®) type are determined, which acts as control and for the Si2323trPr resin (prepared by the "pathway 1" method) according to the temperature, the pH being kept constant at a value of 5.

25 The results obtained are brought together in Figure 3, where the partition coefficient K_{ds} (mL/g) is shown according to T (°C). The curve with unbroken line is related to the Si2323trPr resin ("pathway 1") and the curve with stippled line is related to the silica gel.

This study shows that for the silica gel, the temperature has practically no influence on the adsorption of the uranium, that is, the kinetics is rapid, while for the modified silica Si2323trPr (obtained
5 by the "pathway 1" method), the increase in temperature causes a considerable increase in the effectiveness of the resin, this result shows that the complexing reaction rate is slow.

The extraction of the U (VI) at 80°C with this resin,
10 makes it possible to retain, as static, nearly 90% U (VI) (Kds = 784).

Example 1B

In this example, the influence of the nature of the
15 ligand of the resin on the extraction of uranium VI is studied.

The static partition coefficients of different types of modified, synthesized silicas have been determined according to the operating method described above. The pH
20 being kept equal to 5 and the temperature at 80°C. By way of comparison, under the same conditions the static partition coefficients are determined of a silica gel and the commercial chelating resin AMBERLITE® IRC718 (iminioacetic acid grafted on polystyrene).

25 The results are brought together in Table II, below:

Table II

Static partition coefficient Kds for the different resins studied (pH 5; T = 80°C; t = 18 h, uncertainty = ±20%

Resin	Kd _s
AMBERLITE® IRC718	45
Silica gel	290
Si2222OHtrA	353
Si2323OHtrA	303
Si2222OHtrPr	852
Si2323OHtrPr	1,078
Si2323trPr ("pathway 1")	784
Si2323trPr ("pathway 2")	1,140

5 Because of the high grafted amount of macrocycles, the resin Si2323trPr prepared according to the grafting method, called "pathway 2" has a higher partition coefficient.

10 The comparison of these results with those obtained under the same conditions with the commercial chelating resin AMBERLITE® IRC718 shows that these new chelating resins are remarkable sequestering agents of uranium (VI).

15 Example 2

 In this example, the dynamic exchange capacity of the resins is studied.

20 In fact, the "static" exchange capacity of the resins is an important parameter, but for a method carried out in the dynamic mode on a column, the

"dynamic" exchange capacity is the parameter that really shows the sequestering properties of the resins studied.

The test have been carried out by using the device represented in Figure 4 which in summary is composed of a
5 column (41) with a diameter of 10 mm and a height of 300 mm, provided with a thermostating jacket making it possible to control the temperature with the aid of a thermostatted bath (43) and a peristaltic pump (42) to obtain the desired flow rate.

10 Approximately 12 g of gel are placed in the column (41) after passage into a solution of distilled water. Before each test, the resin is conditioned at different pH values by eluting 500 mL of a buffer solution through the column, than a solution of distilled water to rinse
15 the resin. After this treatment, the column is ready to use.

For the fixation tests, the solution to be purified (44) is eluted on the column from bottom to top (arrow
20 46) at a flow rate on the order of 100 mL.h⁻¹. The samples to be analyzed are collected (45) every 100 mL and the concentration of U(VI) are determined by ICP-AES. The solution is eluted on the column up to where the leak observed corresponds to the concentration of the parent solution.

25 The regeneration tests are carried out by eluting 100 mL of a solution of 2N nitric acid at the same flow rate, but from the top to the bottom of the column (arrow 47) immediately after the fixation tests.

Rinsing of the column is next carried out with the aid of a solution of distilled water. The samples to be analyzed are collected every 10 mL and the concentration of U (VI) is determined by ICP-AES.

5 For each modified silica column, two experiments were carried out.

The "dynamic" exchange capacity depends on a large number of parameters and in particular, on the concentration of the solution to be extracted. In order
10 to obtain the saturation curves that give the variation in concentration of uranium at the outlet of the column (c) according to the volume of solution eluted (V) (see Figure 5) a concentration of uranium has been chosen that is much higher than those observed in the effluents.

15 Generally, it is considered that the saturation volume of the column is reached ($V_1/2$) when the outlet concentration is equal to half of the concentration of the parent solution ($C_0/2$).

20 The measurement of the dynamic mode capacity of the resins according to this procedure has been carried out by calculating the dynamic partition coefficient K_{dd} for each experiment according to the formula:

25
$$K_{dd} = \frac{[\text{amount of uranium trapped}]/[\text{weight of dry resin}]}{[\text{amount of uranium remaining in solution}]/[\text{volume of the solution}]}$$

$$K_{dd} = \frac{[C_0] - [C]}{[C]} \times V/m$$

[Co] = concentration of the solution before extraction (g.mL⁻¹)

[C] = concentration of the solution after extraction (g.mL⁻¹)

5 V = volume of the solution (mL)

m = weight of the resin (g)

The K_{dd} is calculated from the saturation curve obtained when $C = C_0/2$:

10
$$K_{dd} = V/2/m$$

It is appropriate to mention that the saturation curve also makes it possible to calculate the weight of uranium retained, which is approximately equal to
15 $V/2 \times S_0$.

For these experiments, the resins chosen to be tested are Si2323trPr synthesized according to pathways 1 and 2. The silica was systematically chosen as control material.

20

Example 2A

In this example, the influence of the pH for conditioning the resins on the extraction of the uranium (VI) has been studied with the aid of resins used in the
25 method of the invention and with the aid of a control silica gel. The operating method is that given above.

The extraction of the uranium is studied specifically on the resin Si2323trPr (prepared by the "pathway 1" method) for a range of pH values of buffer

solutions for conditioning from 2 to 9 (2.5; 4; 5; 7 and 9), the temperature being constant and equal to 25°C.

The results are brought together in Table III.

5

Table III

Dynamic partition coefficient for the Si2323trPr resin,
according to the pH (T = 25°C, uncertainty = ±10%)

PH	Kdd	
	Si2323trPr ("pathway 1")	Silica gel
2.5	5	5
4	2.6	156
5	3	112
7	3	67
9	6	3

The results obtained that are reported in Figure 6
10 enable the experimental determination of the optimum pH
which is between pH 4 and pH 5. This result is in good
agreement with the thermodynamic study of this new class
of ligands.

Moreover, it is surprising to note the very low
15 capacity of the silica in the dynamic mode relative to
what has been observed in the static mode. Since the
trapping mode of the silica is essentially being carried
out by simple physical adsorption, it may be assumed that
in the dynamic mode, the elution of the solution carries
20 along the adsorbed uranium.

Example 2B

According to the invention, in order to accelerate the complexing rate with resins used, it is necessary to work at a high temperature throughout the method.

5 In this example, therefore, the influence of the temperature on the dynamic partition coefficient is studied at the same time on the silica (control) and on the Si₂₃₂₃trPr resins ("pathway 1") and Si₂₃₂₃trPr ("pathway 2"). The operating method is that described
 10 above, the conditioning pH being kept constant and equal to 4 for the Si₂₃₂₃Pr resin and 9 for the silica. The results obtained are brought together in Table IV and reported in Figure 7.

15

Table IV

Dynamic partition coefficient for silica (pH 9) and
Si₂₃₂₃trPr (pH 4) according to the temperature
(uncertainties = ±10%)

Kdd (l)			
T (°C)	Silica gel	Si ₂₃₂₃ trPr ("pathway 1")	Si ₂₃₂₃ trPr ("pathway 2")
25	6	158	182
50	6	202	266
80	8	242	324

20

It is noted that keeping the column at 80°C makes it possible to increase considerably and surprisingly the effectiveness of the resins used according to the

invention and that the increase is between 50% and 70% according to the cases.

In the best cases, that is, for the use of the Si2323trPr resin ("pathway 2") the observed K_{dd} (324) corresponds to the fixation of 0.33 mmol of uranium per gram of resin (79 mg of uranium per gram of resin).

As has been mentioned previously, the simple use of columns filled with silica, whatever are the conditions of use, leads to very mediocre results.

This study in the dynamic mode clearly shows that the incomparably better results in terms of effectiveness of extraction, represented by the capacity, are obtained in the specific ranges of conditioning pH and temperature of the method according to the invention. The tests demonstrate that the method according to the invention make it possible to reach a decontamination of α -contaminated effluents that has never been obtained by the methods of the prior art.

In Table V, the amount of fixed U (mmol.g) is given according to the conditions of the method.

Table V

Amount of fixed U (mol.g)	Conditions of the method
0.33	Si2323 ("pathway 2"), conditioning at pH4, T=80°C
0.24	Si2323trPr ("pathway 1"), conditioning at pH4, T=80°C
0.16	Si2323trPr ("pathway 1"),

	conditioning at pH4
0.01	Si2323trPr ("pathway 1"), without conditioning

The best capacity is obtained for the use of the Si2323trPr, resin ("pathway 2") at 80°C and after conditioning at pH 4.

5

Example 3

This example concerns regeneration tests in dynamic mode of resins used in the method according to the invention.

10

These tests were carried out according to the optimum conditions for use after having saturated by uranium a column loaded with Si2323trPr resin ("pathway 2"). After saturation, a solution of 2N nitric acid is eluted at the same flow rate, but from top to bottom of the column at ambient temperature.

15

The elution profiles (concentration of uranium (VI) according to the volume of HNO₃ eluted) obtained for each experiment make it possible to calculate the amount of uranium salted out and therefore the level of regeneration:

20

$$\text{Level of regeneration} = \frac{\text{amount of uranium salted out}}{\text{amount of uranium fixed}} \times 100$$

25

By way of example, the type elution profile (Figure 8) presents an elution peak for a concentration

of uranium reaching 80 times that of the parent solution. The level of regeneration calculated is near 100% with few uncertainties. Therefore, it may be considered that the recovery of uranium is quantitative.

5 A study carried out on several consecutive extraction/regeneration cycles (Figure 9) shows that all the cases of salting out of uranium are total and the regeneration of the material total.

10 Example 4

15 In this example, the treatment of real effluents from the CEA centre at VALDUC is carried out by a pilot installation according to the invention comprising two columns. This installation is approximately similar to that of Figure 1 and its operation is also that described above. This pilot installation is used for carrying out the last decontamination, that is, a treatment upstream of the industrial evaporator.

20 We are specifying below the characteristics of the pilot installation and the operating conditions used. These are approximately the optimum conditions for use of the resins previously defined in the dynamic mode.

25 The installation includes a first column filled with silica (12 litres) and a second column filled with Si2323trPr resin.

 The tank for receiving the contaminated effluents has a volume of 1.5 m³; the effluent before being received passes through a filtering bowl provided with three cartridges (filtration diameter 5 µm).

The tank for receiving the treated effluents also has a volume of 1.5 m³.

The entire installation is placed in a retention container of 3 m³.

5 The temperature of the effluent during passage through the column of Si2323trPr resin is 60°C.

The flow rate of the effluent during the fixation phase is 30 to 60 L/h. The regeneration is carried out with a 1N nitric acid solution at the end of which the resins are reconditioned by a buffer solution at pH 4.7.

10 The results of the tests especially with the activities before and after treatment by the device of the invention are brought together in Table VI.

15 Table VI
Effluents treated with the pilot installation according to the invention

Effluent No.	1	2	3		
Volume (m ³)	16	18	12		
Saline load (mg/l)	0.06	0.02	0.02		
Radioelements present	U	Am	U	Pu	Am
Activity before treatment (Bq/m ³)	180	16	320	36	531
Activity after treatment (Bq/m ³)	<LD*	<LD*	<LD*	<LD*	<LD*

20 *The limits of detection (LD) are between 1.5 and 2.5 Bq/m³.

Effluent 1 originated from the accidental drainage of rainwater through a building. This effluent which has not undergone any prior treatment containing, moreover, sludge, algae, leaves.

5 Effluent 2 was an effluent that could not be decontaminated finally by the current installation for treatment of effluents using evaporation and microfiltration and corresponding to the prior art.

10 In fact, as we have already pointed out, this latter does not make it possible to decontaminate finally all types of effluent. The treatment of this effluent has been made possible by the installation of the invention ensuring zero activity.

15 Effluent 3 was an effluent with very low activity which had not undergone any particular prior treatment such as a chemical treatment or evaporation. The effluents possessing this type of activity form a large part of the effluents from the centre, such as that of VALDUC, in addition, the direct treatment of this type of
20 effluent by the method according to the invention forms a very worthwhile alternative which may be integrated within the current installation for treatment of effluents. This type of treatment especially makes it possible to avoid the evaporation step which is much more
25 awkward to use.

The diversity of effluents treated shows that the installation according to the invention is capable of carrying out the recovery of traces of actinides of all

types of effluents with very low activity produced by the VALDUC centre.

This is the important advantage compared with the current method and installation which finally does not
5 allow decontamination of all types of effluents.

The high volumes that have been treated by the pilot installation of the invention are significant and with them make it possible to demonstrate the superiority with respect to the ultrafiltration installation, currently
10 used to carry out the final treatment upstream of the evaporation tower, as much in terms of effectiveness and expenses of investment, operating and maintenance.

Example 5

15

Installation

In this example, at the laboratory stage in glove box, various tests [misspelled word; are] carried out to treat the effluents upstream of the industrial
20 evaporator, with the aid of an installation according to the invention.

This installation which is comparable to that of Figure 1, is however slightly modified, it is described in Figure 2.

25 Within the glove box, the experimental installation conforms to the present invention and is principally composed of the following parts:

- a capacity (201) which directly receives the effluents from the treatment station of the VALDUC centre, a peristaltic positive displacement vacuum pump (202), a filtration capsule (203) with a pore diameter of

5 50 μm ;

- two resin columns mounted in series: a first column (204) filled with silica (silica gel) or a resin of the polyacrylate type (AMBERLITE® IRC86RF) and a second column (205) filled with silica (silica gel) modified by polyazacycloalkanes, preferably, it is a resin called Si2323trPr which has been prepared either by the method called "pathway 1" or by the method called "pathway 2". Each column has a diameter of 1 cm and a height of 30 cm.

15 Each column contains 12g of silica gel or resin;

- a circulation thermostat for keeping the temperature of the columns at 60°C;

- a tank (206) filled with 1N HNO₃, distilled water or buffer solution, connected to a peristaltic positive displacement vacuum pump for carrying out, respectively, the regeneration and the conditioning of the resins in each of the columns (204, 205);

- a tank for recovery of the eluates from the columns (208);

25 - three-way valves (209, 210, 211, 212) at the inlet and outlet of the columns.

Effluents treated

The effluent sampled to carry out this study has a total radiological activity of approximately 6.1 kBq/m³ (Table VII) and a saline load of 0.78 mg/L. It has not undergone any prior chemical treatment such as precipitation or flocculation. The panoramic analysis (Table IX) of this effluent shows that the actinides only represent a tiny part of the elements present (< 1ppm). This effluent contains in the great majority alkali and alkaline-earth elements (99.29%), principally Na (84.38%), Ca (11.01%), K (3.44%) and Mg (0.45%). This effluent also contains B (0.59%) and several metal elements (Ti, Ni, W, Al and Zn; for a total of 0.15%).

Table VII

Activity and concentration of the sampled effluent ($\pm 20\%$)

	U	Pu	Am
Activity (kBq/m ³)	4.7	0.54	0.83
Concentration	185 ppb	0.24 ppt	6 ppq

Procedure

Just like the operating of the installation and the pilot installation according to the invention previously presented, the operating of the experimental installation may be broken down into two phases:

Fixation

The effluents originating directly from the VALDUC treatment station of effluents are introduced into the

glove box where they are discharged into the capacity (201) then taken back by the pump (203).

After passage on the filter (203) making it possible to be rid of impurities (dust, particles etc.), the solution crosses through the resin bed of each from the bottom to the top. The first column (204) as has already been seen, filled with silica or a resin of the polyacrylate type (AMBERLITE® IRC86F) and the second column(205) filled with silica modified with macrocycles. These latter are poured at the head of the column and are recovered in the capacity (208) where regular samples are taken to be analyzed by α spectrometry or ICP-MS.

Regeneration

The regeneration of the resins is carried out by elution of 2N nitric acid from the top to the bottom of the column. The eluates are recovered in the capacity (208) where regular samples are taken for analyses. The resins then require a reconditioning before beginning a new cycle. The latter is carried out by elution of water, then a buffer solution at pH 4.7 always from the top to the bottom of the column.

Combination of resins used

The three combinations of the following resins have been proposed (Table VIII)

Table VIII

Combination	1st column	2nd column
(a)	Silica	Si2323trPr ("pathway 1")
(b)	Silica	Si2323trPr ("pathway 2")
(c)	AMBERLITE® IRC86RF	Si2323trPr ("pathway 2")

Result and discussion

The results of the tests carried out are brought
5 together in Table IX.

The elution profiles observed show that the
effluents are totally decontaminated for a volume less
than the leakage volume of radioelements (v =
approximately 1 L). Panoramic analyses were carried out
10 just before this leakage volume, in order to evaluate the
selectivity of the method (see Table IX).

Table IX

Panoramic analysis carried out after elution of a litre of effluent 1 (before the

leakage volume)

Family of elements	Element	Starting effluent		After passing SiO ₂ + Si2323trPr (pathway 1)		After passing SiO ₂ + Si2323trPr (pathway 2)		After passing AMBERLITE IRC86 + Si2323trPr (pathway 2)	
		C (ppb)	Level	C (ppb)	Level of purification	C (ppb)	Level of purification	C (ppb)	Level of purification
Alkali/alkaline earth	Na	330,000	84.38%	300,000	9%	307,000	7%	260,000	21%
	K	23,000	3.44%	21,000	9%	23,000	0%	16,000	30%
	Ca	75,000	11.01%	65,000	13%	75,000	0%	<5,000	>87%
	Mg	1,980	0.45%	1,770	11%	1,920	3%	170	91%
	Sr	84	59 ppm	68	19%	81	3%	<50	>40%
	Ba	240	100 ppm	220	8%	275	0%	<50	>79%
Transition metals	Li, Be, Cs	<50		<50		<50		<50	
	Ti	240	300 ppm	210	12%	230	4%	<50	>75%
	Ni	370	450 ppm	350	5%	370	0%	240	35%
	W	50	18 ppm	45	10%	48	4%	<20	>60%
	Fe, V, Cr, Mn, Co, Mo, Ag	<50		<50		<50		<50	

Considering these results:

- The alkalis and alkaline-earths are retained very little by systems (a) and (b), the levels of purification oscillating between 8 and 19% for (a) and between 0 and 5 7% for (b). The selectivity of the resins Si2323trPr is therefore high for this family of elements and it increases appreciably when going from a resin elaborated by the "pathway 1" to a resin elaborated by "pathway 2".

If the first column contains AMBERLITE® IRC86F resin 10 (c), the effluent is found almost totally purified of alkaline-earth elements (Ca, Mg, Sr and Ba) but on the other hand, the levels of purification are only 21 and 30% for the alkali elements Na and K, respectively.

- The transition metals are also retained very 15 little by the systems (a) and (b), the levels of purification oscillate between 5 and 12% for (a) and between 0 and 4% for (b). The selectivity of the resins Si2323trPr is therefore high for this family of elements and once again, it seems to increase appreciably when 20 passing from a resin elaborated by pathway 1 to a resin elaborated by pathway 2.

If the first column contains AMBERLITE® IRC86F resin (c), the effluent is found to be almost totally purified of Ti and W, but on the other hand, the level of 25 purification is only 35% for Ni.

- Zn and Al are moderately retained on the different columns; the levels of purification are on the order of 40% in all cases.

- Finally, B is slightly retained, with identical levels of purification, on the order of 15%.

These experiments show that these resins have very good selectivity, particularly with respect to alkalis, alkaline-earths, and transition metals. The selectivity is even more marked for the resin Si2323trPr elaborated according to "pathway 2" compared with the resin Si2323trPr, elaborated according to "pathway 1". Moreover, the coupling of these resins with the AMBERLITE® IRC86F resin makes it possible to purify a good part of the alkaline-earths and transition metals.

In spite of this high selectivity, the high salinity of the effluents (essentially in alkalis and alkaline-earths) held at this level of the treatment cycle rapidly contributes to saturating the resins.

Thus, for metals in the actinide series, these experiments show that it is possible to directly treat effluents having this level of activity, in spite of rather low leakage volumes observed (between 50 and 70 column volumes), attributable to this high salt effect (the actinides only represent a ppm fraction of all the elements). This study shows that the effectiveness of such a method of treatment of radioactive elements depends less on the level of activity of the effluent than on its saline load.

CLAIMS

1. Method for removal of metal cations contained in a liquid in which said liquid is brought into contact at a temperature higher than or equal to 60°C, with a chelating ion exchange resin formed from
5 polyazacycloalkane grafted on a solid support, said resin having been conditioned, previously to said contacting, at a pH of 4 to 6.
2. Method according to Claim 1 in which the
10 contacting is carried out at a temperature of 60 to 80°C.
3. Method according to Claim 1 in which the conditioning pH is 4 to 5.
- 15 4. Method according to any one of Claims 1 to 3 in which the conditioning of said resin is carried out by contacting said resin with a buffer solution, especially aqueous, in which the pH is 4 to 6, possibly preceded and/or followed by a rinsing of the resin with a major
20 solvent of the liquid to be treated, especially with distilled water.
5. Method according to Claim 1 carried out continuously, said resin being placed in at least one
25 column passed through by a current of liquid to be treated.

6. Method according to Claim 1 comprising, in addition, a regeneration step of said resin, when the latter is saturated by the fixed metals.

5 7. Method according to Claim 5 and Claim 6 in which said regeneration is carried out by passing a regeneration solution through the column(s) in the reverse direction from the direction of circulation of the liquid to be treated.

10

8. Method according to Claim 7 in which said regeneration solution is chosen from the acid solutions, for example, nitric acid.

15

9. Method according to Claim 7 or Claim 8 in which at the end of the regeneration step, said regeneration solution containing the metals initially fixed on the resin is treated to recover the metals.

20

10. Method according to any one of Claims 1 to 9 comprising a prior step for treatment of the liquid by contacting with an ion exchanger or organic or mineral adsorbent different from said polyazacycloalkane resin grafted on a support.

25

11. Method according to Claim 10 in which said adsorbent is chosen from the silica gels.

12. Method according to Claim 10 in which said ion exchanger is chosen from resins of the polyacrylate type, resins of the AMBERLITE® type.

5 13. Method according to Claim 10 in which said prior treatment step is carried out continuously, said ion exchanger or adsorbent being placed in at least one column passed through by a current of liquid to be treated and positioned upstream of said column filled
10 with resin.

14. Method according to Claim 11 in which said ion exchanger or adsorbent is regenerated when it is saturated by the fixed metals under the same conditions
15 as the resin and at the same time as regeneration of the latter and with the same regeneration solution.

15. Method according to Claim 1 in which said metal cations to be removed are metal cations chosen from
20 transition metals, heavy metals, metals from group IIIA of the periodic table, lanthanides, actinides and alkaline-earth metals.

16. Method according to Claim 13 in which said
25 metal cations are chosen among the cations of U, Pu, Am, Ce, Eu, Al, Gd, Cr, Mn, Fe, Co, Ni, Cu, Zn, Ag, Cd, B, Au, Hg, Pb, As, Ca, Sr, Mg, Be, Ba and Ra.

17. Method according to any one of Claims 1 to 16
in which the treated liquid is an aqueous liquid.

18. Method according to any one of Claims 1 to 17
5 in which the treated liquid is a radioactive aqueous
effluent with low activity.

19. Method according to Claim 19 in which said
effluent is the aqueous effluent with low activity
10 originating from the industrial evaporator of the
treatment installation of effluents from a nuclear
installation.

20. Method according to Claim 16 and Claim 17 in
15 which the liquid is a biological fluid, such as blood and
the cations removed are copper and aluminium.

21. Method according to any one of Claims 1 to 20
in which said chelating ion exchange resin formed from
20 polyazacycloalkane grafted on a solid support fulfils one
of the three formulas (I), (II) and (III) below:

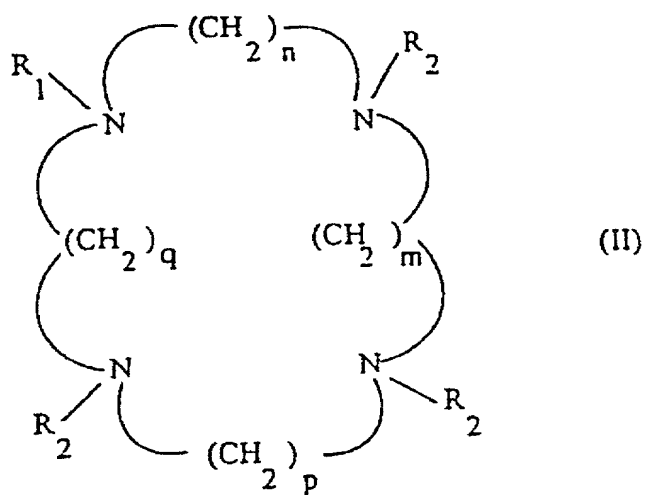
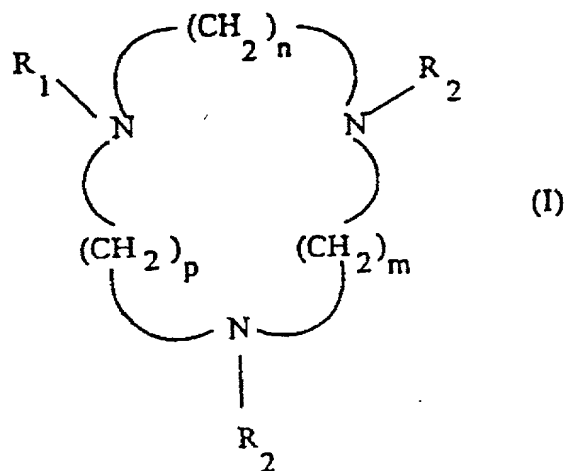

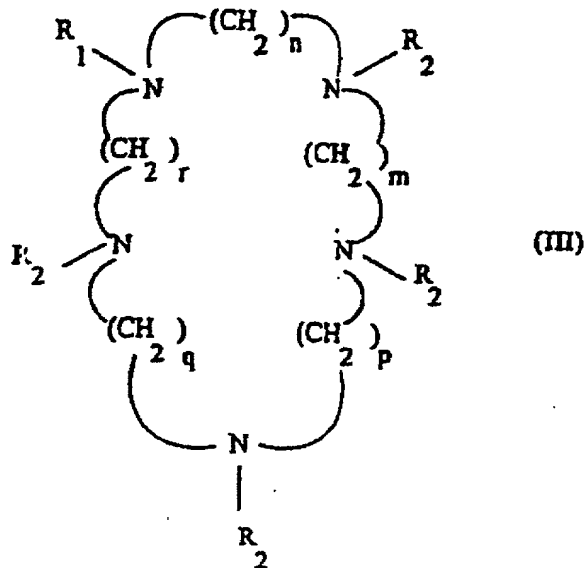

in which n , m , p , q , r which may be the same or different are equal to 2 or 3, R_1 is a solid support, R_2 represents the hydrogen atom or the $(CH_2)_2-R_3$ group, R_3 being a functional group chosen from the group formed by $COOH$, $CONH_2$, CH_2OH , CN or $COOR_4$, R_4 representing an alkyl or benzyl group, or R_2 represents the $-(CH_2)-R_5$ group, R_5 representing $COOH$ or PO_3R_6 , R_6 representing an alkyl group or hydrogen.

22. Method according to any one of Claims 1 to 21 in which the solid support is an organic polymer that may or may not be crosslinked.

23. Method according to Claim 22 in which the solid support is a residue of an organic polymer that may or

may not be crosslinked with alkyl halide end, preferably alkyl chloride end.

24. Method according to Claim 23 in which the solid support is a residue of chloromethyl polystyrene.

25. Method according to Claim 24 in which the grain size distribution of said chloromethyl polystyrene is between 20 and 400 mesh and, preferably, between 20 and 70 mesh.

26. Method according to Claim 21 in which R1 is a solid support derived from silica fulfilling formula:

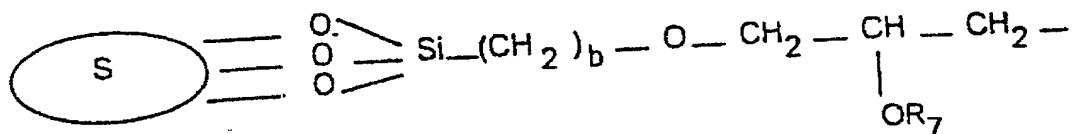

15

where [sic; or] the formula:

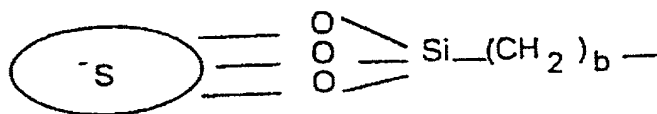

20

S representing a silica gel, b being between 1 and 4 and preferably equal to 3 and R7 being an alkyl group or a hydrogen atom.

5 27. Method according to Claim 26 in which the grains size distribution of the solid support derived from silica is between 20 and 400 mesh and, preferably between 20 and 70 mesh.

10 28. Method according to Claim 21 in which said resin is chosen from the following resins:

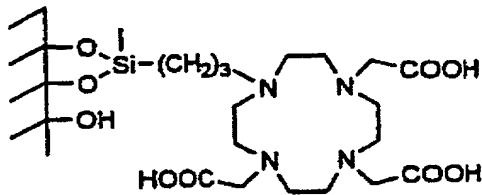

Si2222trA

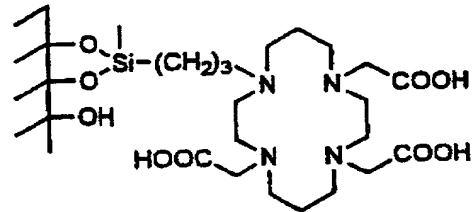

Si2323trA

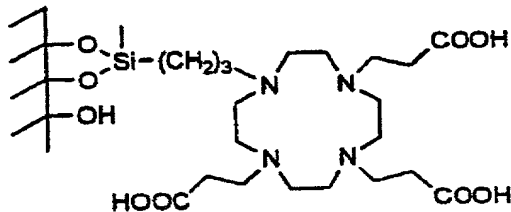

Si2222trPr

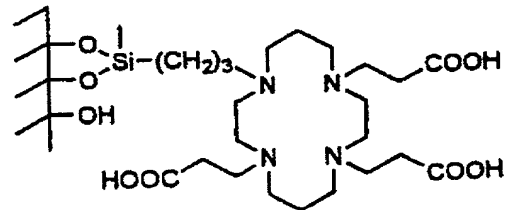

Si2323trPr

29. Method according to Claim 1 in which said solid support is silica, and said resin is prepared by a method in which silica is reacted with a spacer arm, then with azacycloalkane and then the substitution of the free
5 amine functions of the polyazacycloalkane is carried out by groups especially including a carboxylic function.

30. Method according to Claim 1 in which said solid support is silica and said resin is prepared by a method
10 in which first, an unsubstituted polyazacycloalkane, such as cyclam or cyclene is reacted with a spacer arm, then said polyazacycloalkane carrying a spacer arm is grafted on the silica.

31. Method according to Claim 30 in which in
15 addition, said polyazacycloalkane carrying a spacer arm is functionalized prior to its grafting on the silica.

32. Method according to Claim 30 or Claim 31 in
20 which the amount of polyazacycloalkane grafted per unit weight of solid support, such as silica is greater than 0.4 mmol.g⁻¹.

33. Installation for removal of metal cations
25 contained in a liquid comprising at least a column filled with a chelating ion exchange resin formed from a polyazacycloalkane fixed on a support, means for causing a current of liquid to be treated to pass through said column, means for conditioning said resin at a pH of 4 to

6 and means for heating said resin to a temperature greater than or equal to 60°C.

5 34. Installation according to Claim 33 comprising, in addition, a column filled with ion exchanger or organic or mineral adsorbent different from said polyazacycloalkane resin grafted on a support, placed upstream of said column filled with resin.

10 35. Installation according to Claim 33 or Claim 34 comprising in addition, means for regenerating said chelating ion exchange resin and possibly, said ion exchanger or organic or mineral adsorbent.

ABSTRACT OF THE DISCLOSUREMETHOD AND INSTALLATION FOR REMOVAL OF METAL CATIONS
FROM A LIQUID BY RESINS WITH POLYAZACYCLOALKANES GRAFTED
ON A SUPPORT

The invention is related to a method and an installation for removal of metal cations contained in a liquid, in which said liquid is brought into contact at a temperature greater than or equal to 60°C with a chelating
5 ion exchange resin formed from a polyazacycloalkane grafted on a solid support, said resin having been conditioned, previously to said contacting, at a pH of 4 to 6.

10 No figure

204200 SHEET

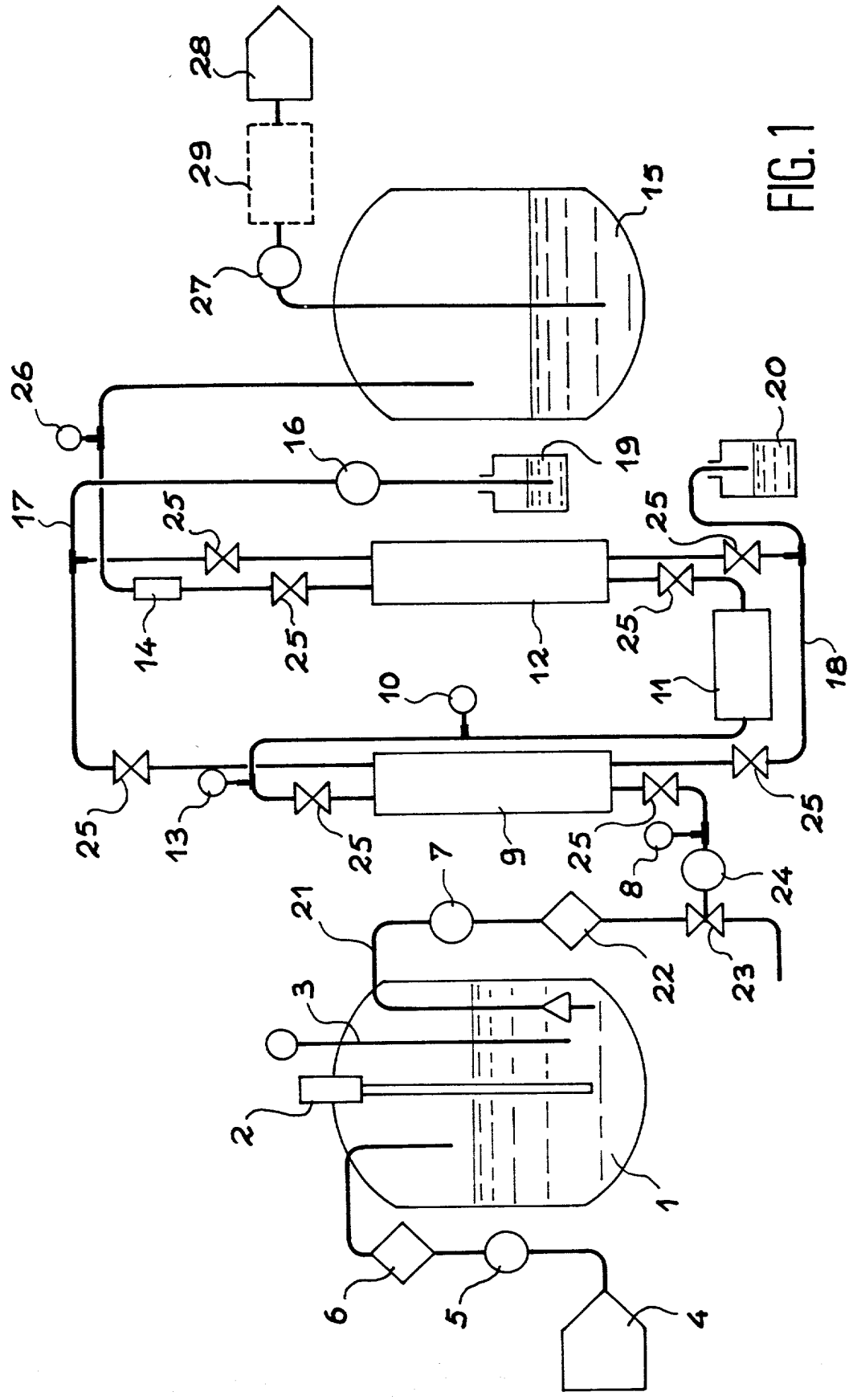

FIG. 1

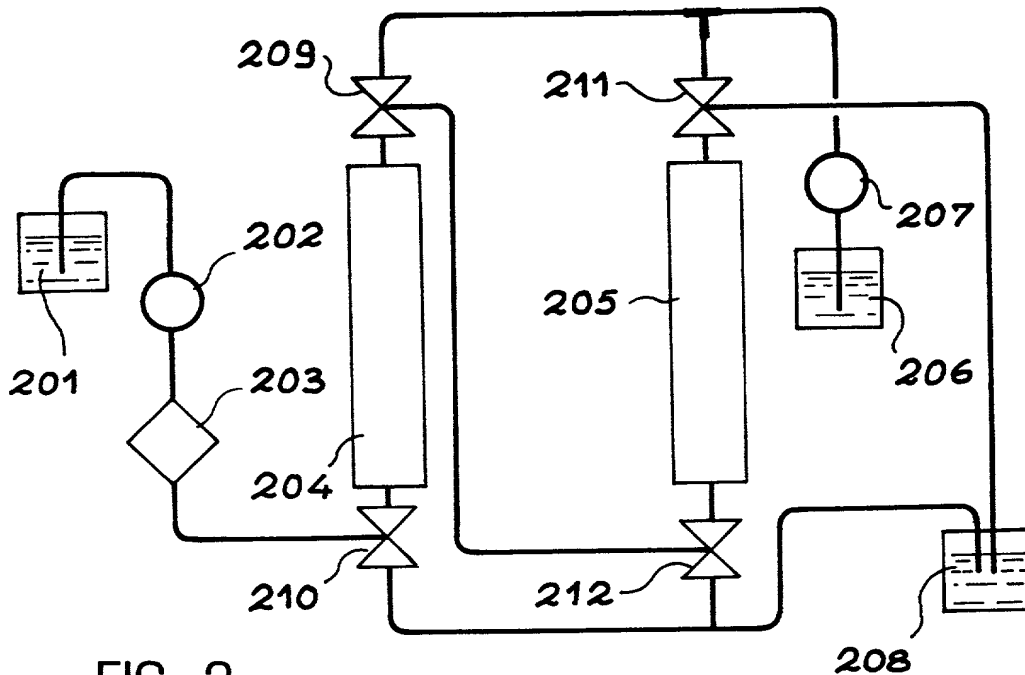

FIG. 2

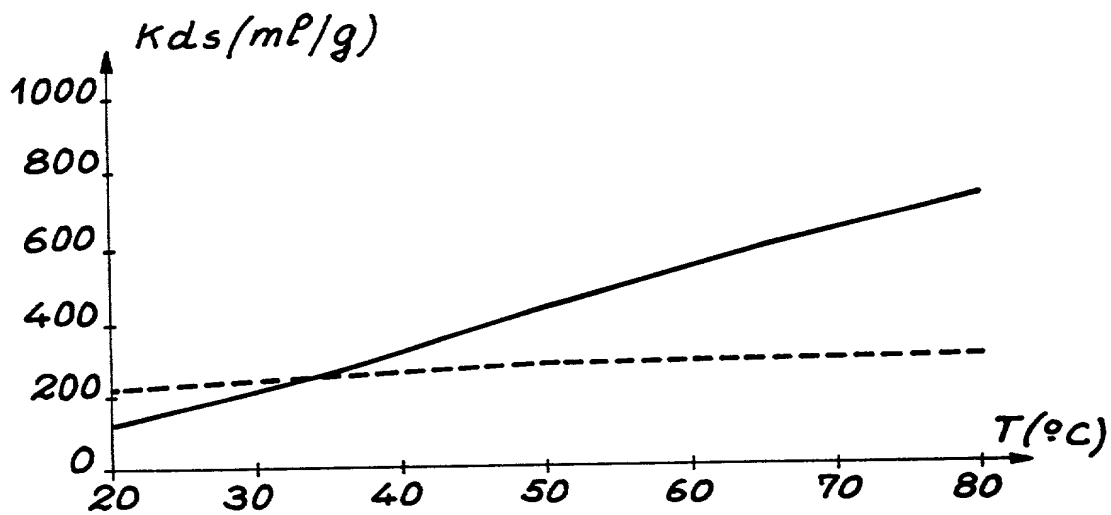

FIG. 3

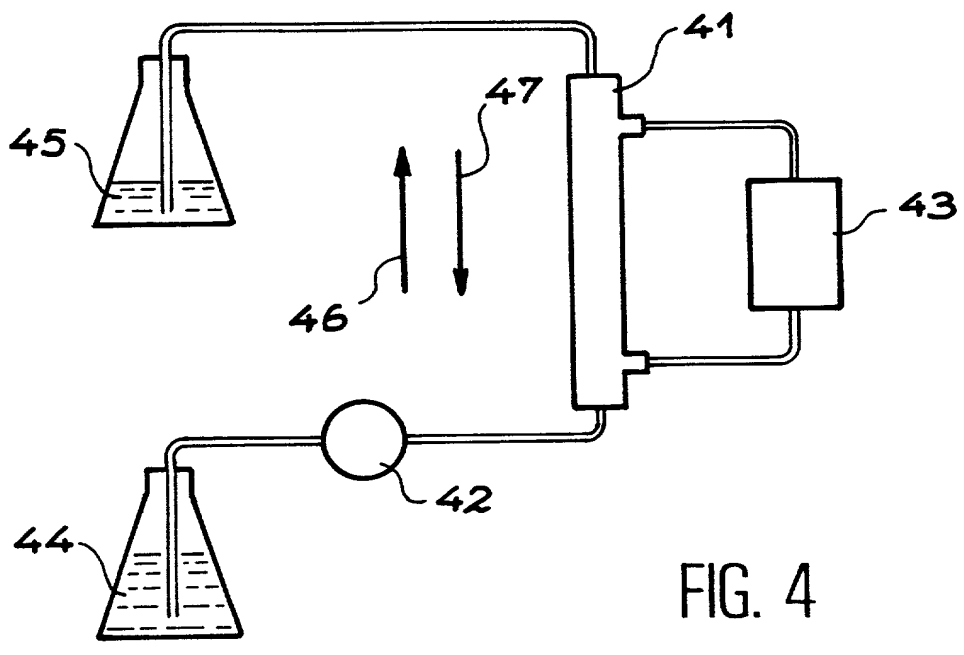

FIG. 4

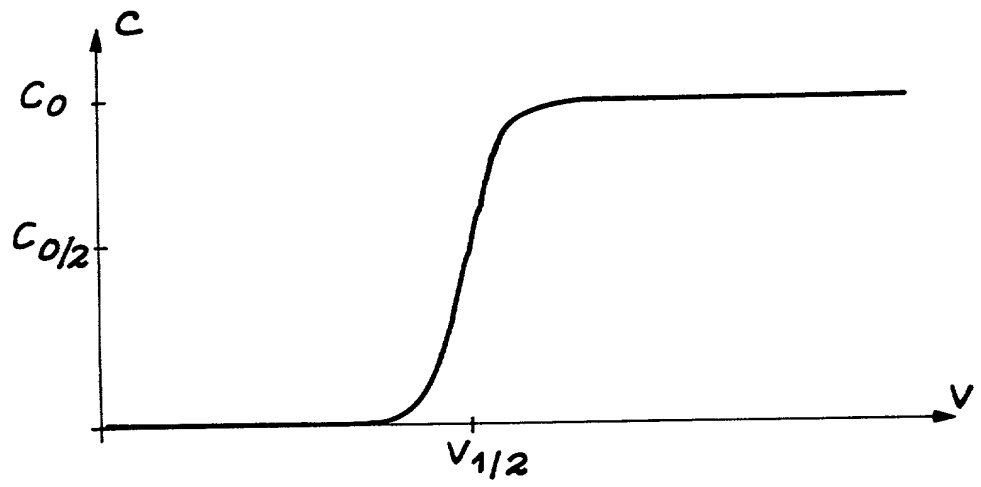

FIG. 5

10089869001

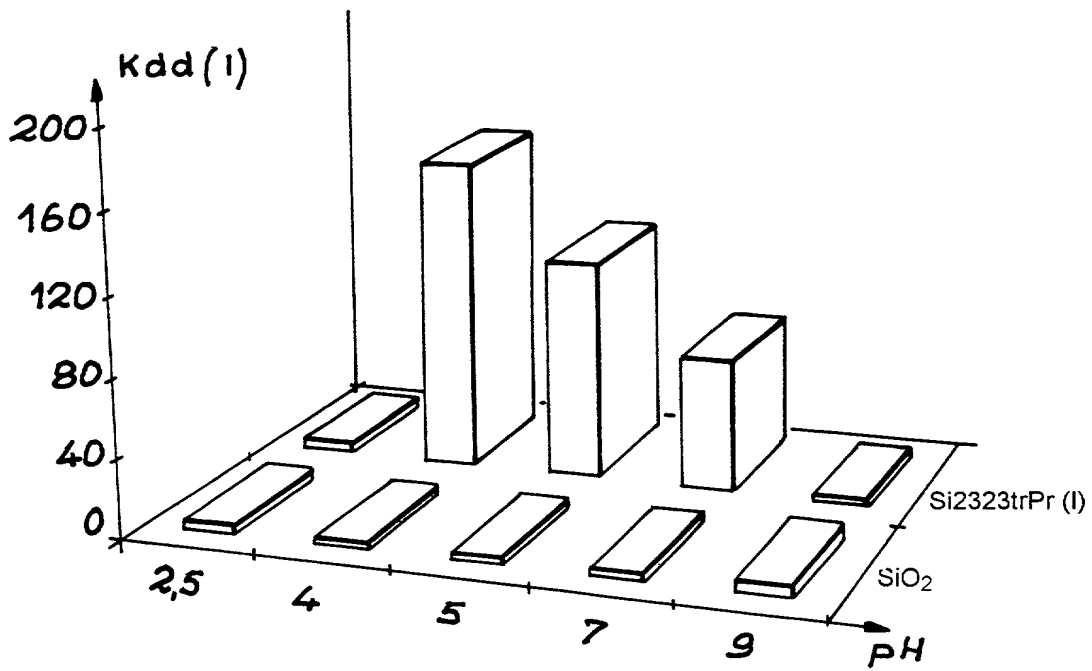

FIG. 6

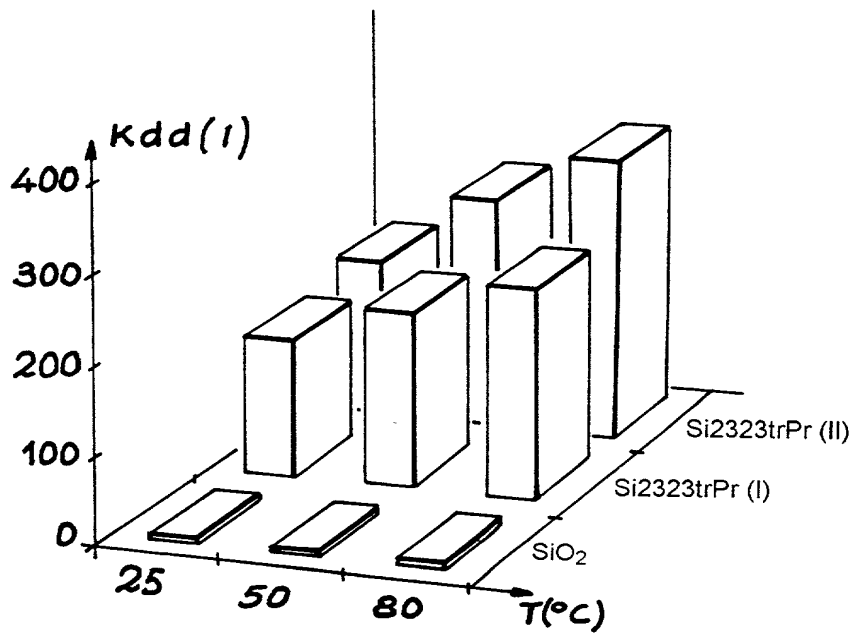

FIG. 7

5 / 5

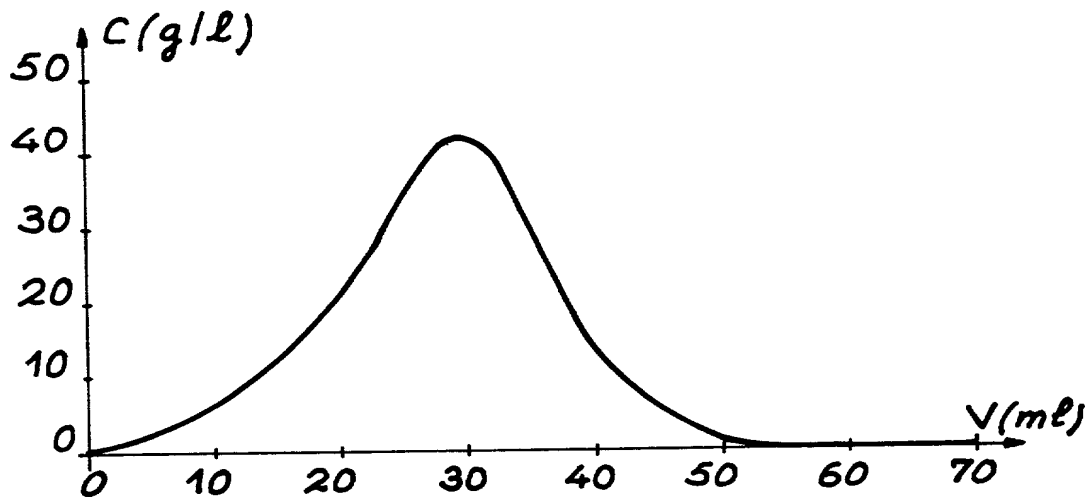

FIG. 8

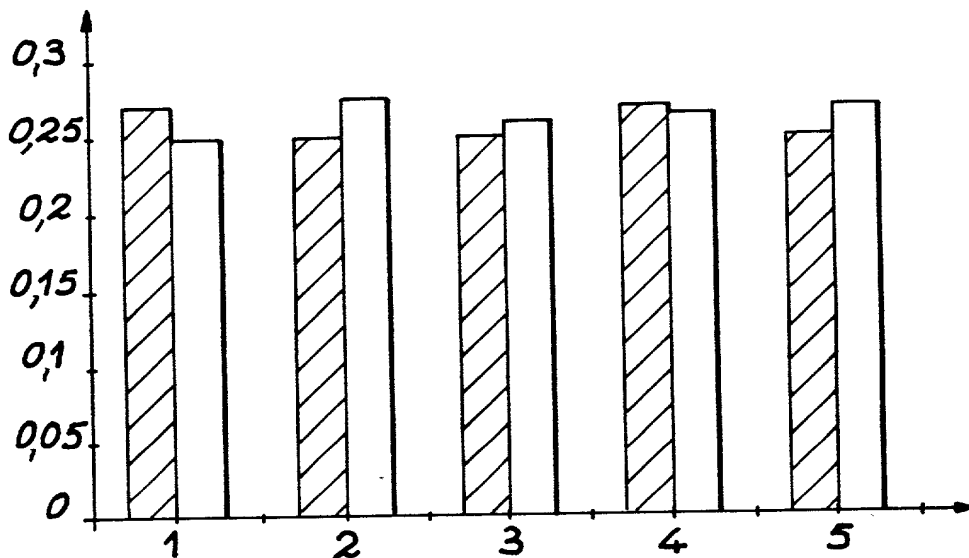

FIG. 9

Declaration, Power Of Attorney and Petition

WE (I) the undersigned inventor(s), hereby declare(s) that :

My residence, post office address and citizenship are as stated below next to my name,

We (I) believe that we are (I am) the original, first, and joint (sole) inventor(s) of the subject matter which is claimed and for which a patent is sought on the invention entitled

METHOD AND INSTALLATION FOR REMOVAL OF METAL CATIONS FROM A LIQUID
BY RESINS WITH POLYAZACYCLOALKANES GRAFTED ON A SUPPORT

the specification of which

- is attached hereto.
- was filed on
as Application Serial No.
and amended on
- was filed as PCT international application
Number PCT/FR00/02374
on August 25, 2000
and was amended under PCT Article 19
on

We (I) hereby state that we (I) have reviewed and understand the contents of the above-identified specification, including the claims, as amended by any amendment referred to above.

We (I) acknowledge the duty to disclose information known to be material to the patentability of this application as defined in Section 1.56 of Title 37 Code of Federal Regulations.

We (I) hereby claim foreign priority benefits under 35 U.S.C. § 119 (a)-(d) or § 365 (b) of any foreign application(s) for patent or inventor's certificate, or § 365 (a) of any PCT International application which designated at least one country other than the United States, listed below and have also identified below, by checking the box, any foreign application for patent or inventor's certificate, or PCT International application having a filing date before that of the application on which priority is claimed. Prior Foreign Application (s)

Application No.	Country	Day/month/Year	Priority Claimed	
99 10861	FRANCE	27 AUGUST 1999	<input checked="" type="checkbox"/> YES	<input type="checkbox"/> NO
_____	_____	_____	<input type="checkbox"/> YES	<input type="checkbox"/> NO
_____	_____	_____	<input type="checkbox"/> YES	<input type="checkbox"/> NO
_____	_____	_____	<input type="checkbox"/> YES	<input type="checkbox"/> NO

We (I) hereby claim the benefit under Title 35, United States Code, § 119 (e) of any United States provisional application(s) listed below.

_____ (Application Number)	_____ (Filing Date)
_____ (Application Number)	_____ (Filing Date)

We (I) hereby claim the benefit under 35 U.S.C. §120 of any United States application(s), or § 365(c) of any PCT International application designating the United States, listed below and, insofar as the subject matter of each of the claims of this application is not disclosed in the prior United States or PCT International application in the manner provided by the first paragraph of 35 U.S.C. § 112, I acknowledge the duty to disclose information which is material to patentability as defined in 37 CFR § 1.56 which became available between the filing date of prior application and the national or PCT International filing date of this application.

20080508

Application Serial No.	Filing Date	Status (pending, patented, abandoned)
_____	_____	_____

And we (I) hereby appoint : Norman F. Oblon, Registration Number 24,618; Marvin J. Spivak, Registration Number 24,913; C. Irvin McClelland, Registration Number 21,214; Gregory J. Maier, Registration Number 25,599; Arthur I. Neustadt, Registration Number 24,854; Richard D. Kelly, Registration Number 27,757; James D. Hamilton, Registration Number 28,421; Eckhard H. Kuesters, Registration Number 28,870; Robert T. Pous, Registration Number 29,099; Charles L. Gholz, Registration Number 26,395; Vincent J. Sunderdick, Registration Number 29,004; William E. Beaumont, Registration Number 30,996; Steven B. Kelber, Registration Number 30,073; Robert F. Gnuse, Registration Number 27,295; Jean-Paul Lavalleye, Registration Number 31,451; William B. Walker, Registration Number 22,498; Timothy R. Schwartz, Registration Number 32,171; Stephen G. Baxter, Registration Number 32,884; Martin M., Zoltick, Registration Number 35,745; Robert W. Hahl, Registration Number 33,893; and Richard L. Treanor, Registration Number 36,379; our (my) attorneys, with full powers of substitution and revocation, to prosecute this application and to transact all business in the Patent Office connected therewith; and we (I) hereby request that all correspondence regarding this application be sent to the firm of OBLON, SPIVAK, McCLELLAND, MAIER & NEUSTADT, P.C., whose post Office Address is : Fourth Floor, 1755 Jefferson Davis Highway, Arlington, Virginia 22202.

We (I) declare that all statements made herein of our (my) own knowledge are true and that all statements made on information and belief are believed to be true ; and further that these statements were made with the knowledge that willful false statements and the like so made are punishable by fine or imprisonment, or both, under Section 1001 of Title 18 of the United States Code and that such wilful false statements may jeopardise the validity of the application or any patent issuing thereon.

CHOLLET Hervé

 NAME OF FIRST SOLE INVENTOR

[Signature]

 Signature of Inventor

January 29, 2002

 Date

Residence: Résidence Les Jardins de
Nicolas, 3A rue R. Delaunay
21000 DIJON FRANCE AKX

Citizen of : FRANCE

Post Office Address : The same as residence

BABOU HOT Jean-Louis

200

NAME OF SECOND INVENTOR

Signature of Inventor

January 29, 2002

Date

Residence: 8 rue sur le Val

21121 FONTAINE LES DIJON, FRANCE

Citizen of: France

Post Office Address : The same as residence

BARBETTE Frédéric

300

NAME OF THIRD INVENTOR

Signature of Inventor

January 29, 2002

Date

Residence: 4 rue du Four

52190 VAUX SOUS AUBIGNY , FRANCE

Citizen of: FRANCE

Post Office Address : The same as residence

GUILARD Roger

400

NAME OF FOURTH INVENTOR

Signature of Inventor

January 29, 2002

Date

Residence: 48 rue du Cottage

21121 FONTAINE LES DIJON, FRANCE

Citizen of: FRANCE

Post Office Address : The same as residence

Residence : _____

NAME OF FIFTH INVENTOR

Citizen of : _____

Signature of Inventor

Post Office Address : The same as residence

Date